



↑
Magnetic installation easy and firm
↓



Magnetic track light simplify your life

- Adopts Modules concept, allowing the magnetic track system adapt to any changes in the space;
- Tool free installation; positioned and re-positioned the magnetic modules conveniently;
- Choose from a variety of LED light modules to meet personalized solution;
- The number of light modules can be added or moved freely;
- Low voltage safe, no-touch hazard

Secure Locking Support

Equipped with mechanical lock to make sure the modules are secured to the track. Press the two side buttons to unlock the modules.





combined with the highest capacitance value and lowest ESR, make the magnetic driver have the characteristic of frequency stability and open-circuit failure mode, etc.

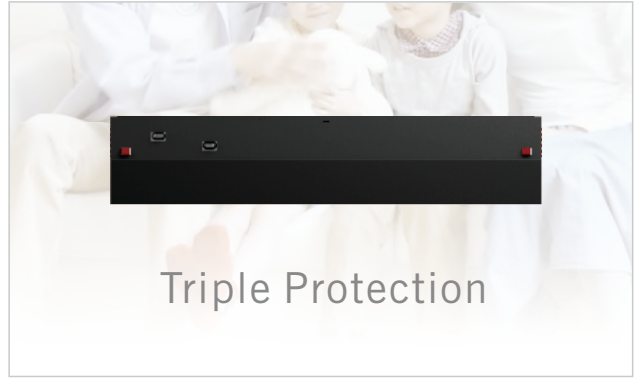

Short-circuit Protection

Over-load protection

over-voltage protection

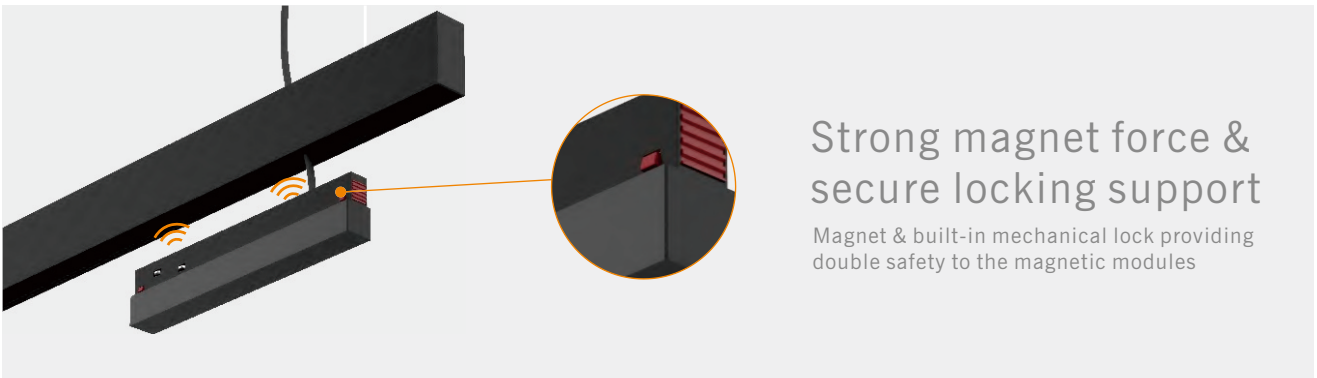



R20

MAGNETIC
TRACK LIGHT

Magnetic20

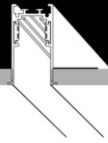

Recessed

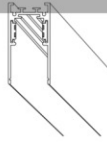

Surface

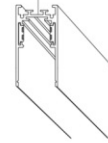

Suspended

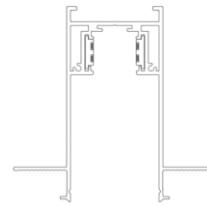

48V Magnetic Track System

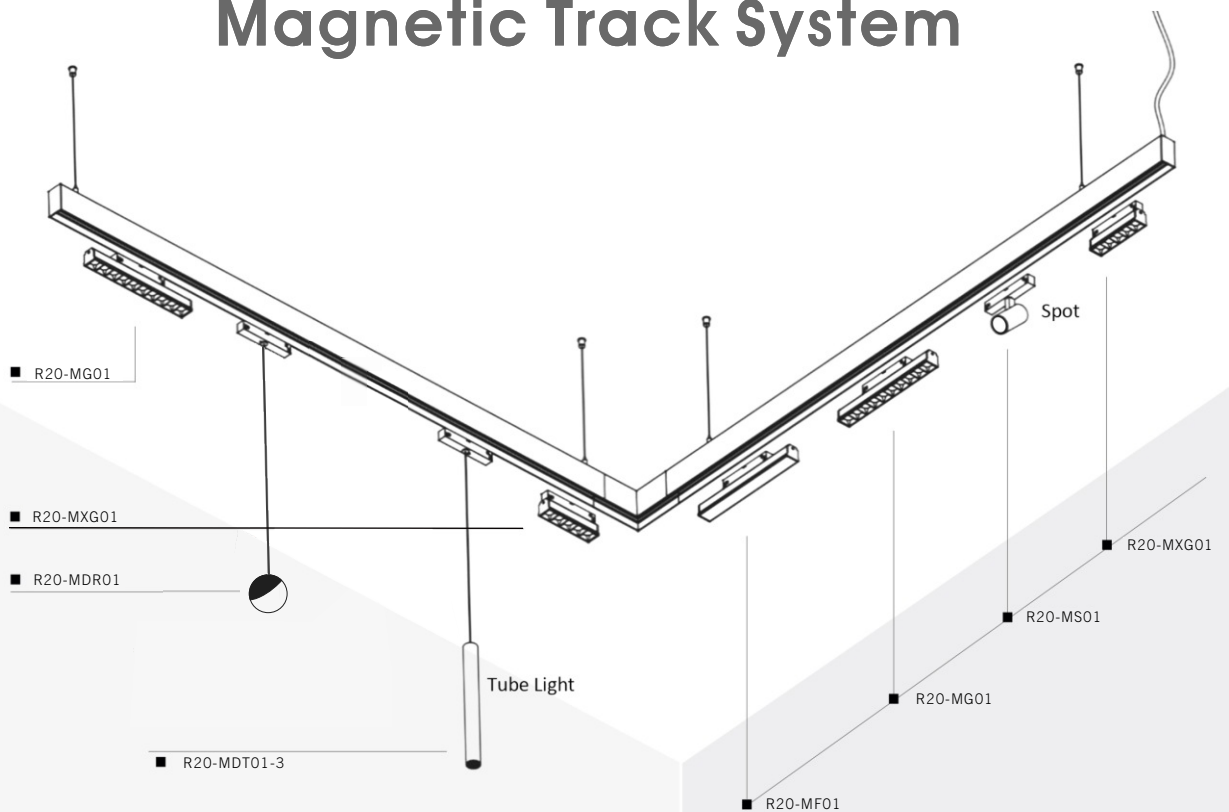

Realdot

MAGNETIC TRACK LIGHT



**CCT
ADJUST**

**ONE LIGHT
TAKES CARE OF EVERYTHING**

3000K-4000K-6000K
Toggle the switch to adjust the color temperature



Zoomable
15-60D



One light takes care of everything

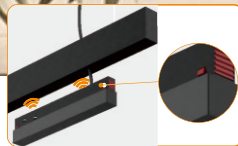

Strong magnet force & built-in lock



Magnetic installation easy and firm



Upgrade magnetic track rail



R20-MS02-10W



R20-MS02-15W



R20-MG02-6



R20-MG02-12



R20-MG02-18



R20-MDT02-9



R20-MF02-10



R20-MF02-20



R20-MXG02-6



R20-MXG02-12



R20-MXG02-18

R20-MF01-10/20/30/40

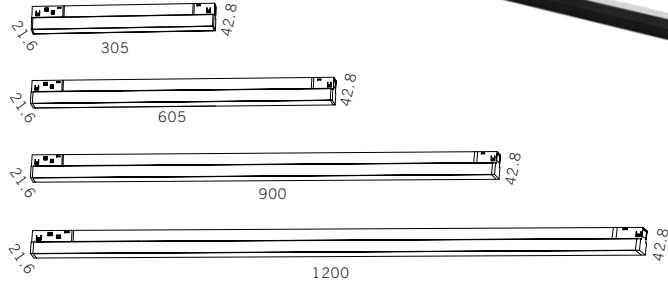

Product Code	Watt	CCT	>CRI	Voltage	LUMEN	Product Size	Finish	System Options
R20-MF01-10	10W	3/4/5000K	Ra90	48V	700lm	305x21.6x42.8	■ BK	No Dim, Dali,
R20-MF01-20	20W	3/4/5000K	Ra90	48V	1400lm	605x21.6x42.8	□ WH	0-10V,
R20-MF01-30	30W	3/4/5000K	Ra90	48V	2100lm	900x21.6x42.8		Bluetooth,
R20-MF01-40	40W	3/4/5000K	Ra90	48V	2800lm	1200x21.6x42.8		Zigbee

Beam angle



R20-MF03-6/12/18

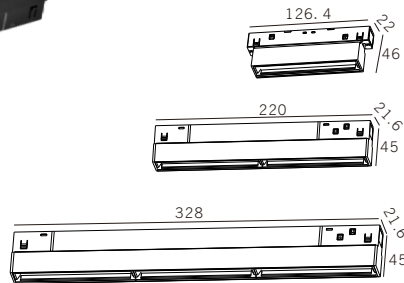

Product Code	Watt	CCT	>CRI	Voltage	LUMEN	Product Size	Finish	System Options
R20-MF03-6	6W	3/4/5000K	Ra90	48V	480lm	126.4x22X46	■ BK	No Dim, Dali,
R20-MF03-12	12W	3/4/5000K	Ra90	48V	960lm	220x21.6X45	□ WH	0-10V,
R20-MF03-18	18W	3/4/5000K	Ra90	48V	1440lm	328x21.6X45		Bluetooth, Zigbee

Beam angle



R20-MFT01-6/12

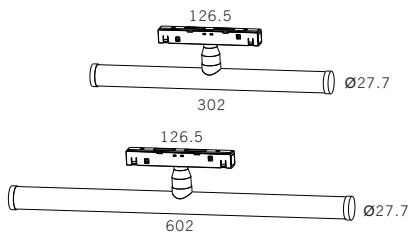

Product Code	Watt	CCT	>CRI	Voltage	LUMEN	Product Size	Finish	System Options
R20-MFT01-6	6W	3/4/5000K	Ra90	48V	600lm	302xØ27.7	■ BK	No Dim, Dali, 0-10V, Bluetooth, Zigbee
R20-MFT01-12	12W	3/4/5000K	Ra90	48V	1200lm	602xØ27.7	□ WH	

Beam angle

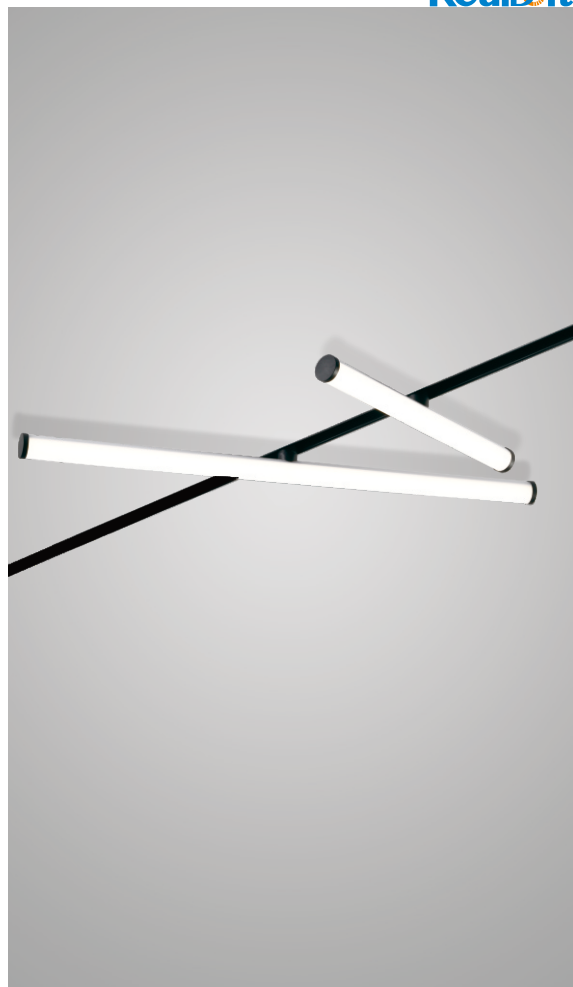

R20-MF02D/IN-20

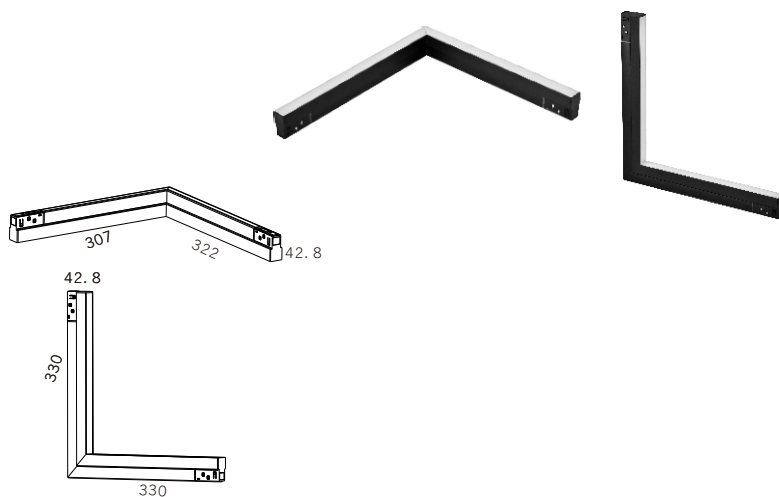

Product Code	Watt	CCT	>CRI	Voltage	LUMEN	Product Size	Finish	System Options
R20-MF02D-20	20W	3/4/5000K	Ra90	48V	1400lm	307x322x42.8	■ BK	No Dim, Dali, 0-10V, Bluetooth, Zigbee
R20-MF02IN-20	20W	3/4/5000K	Ra90	48V	1400lm	330x330x42.8	□ WH	

Beam angle



R20-MS01-3/5

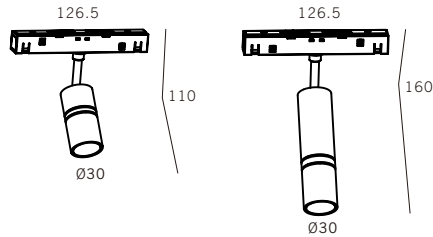
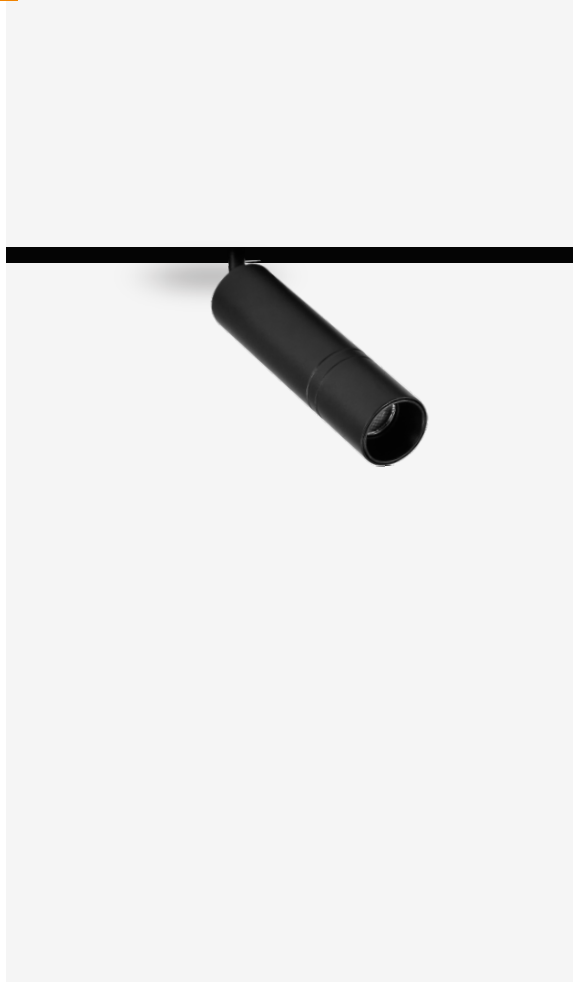

Product Code	Watt	CCT	>CRI	Voltage	LUMEN	Product Size	Finish	System Options
R20-MS01-3	3W	3/4/5000K	Ra90	48V	220lm	Ø30x110x126.5	■ BK	No Dim, Dali, 0-10V, Bluetooth, Zigbee
R20-MS01-5	5W	3/4/5000K	Ra90	48V	280lm	Ø30x160x126.5	□ WH ■ BR	

Beam angle

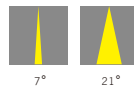

R20-MS01-7/12

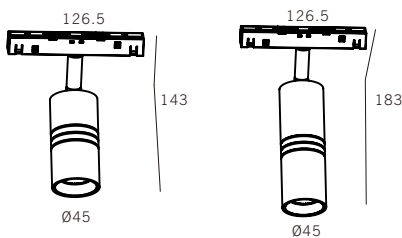
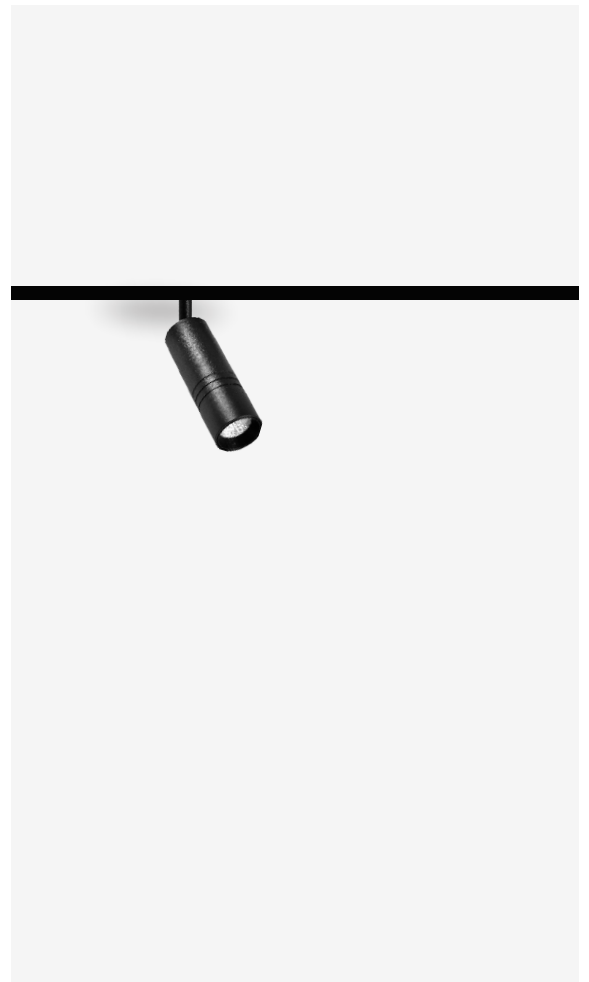

Product Code	Watt	CCT	>CRI	Voltage	LUMEN	Product Size	Finish	System Options
R20-MS01-7	7W	3/4/5000K	Ra90	48V	560lm	Ø45x143x126.5	■ BK	No Dim, Dali, 0-10V, Bluetooth, Zigbee
R20-MS01-12	12W	3/4/5000K	Ra90	48V	960lm	Ø45x183x126.5	□ WH ■ BR	

Beam angle

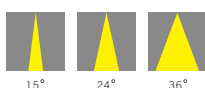

R20-MS01-15/20

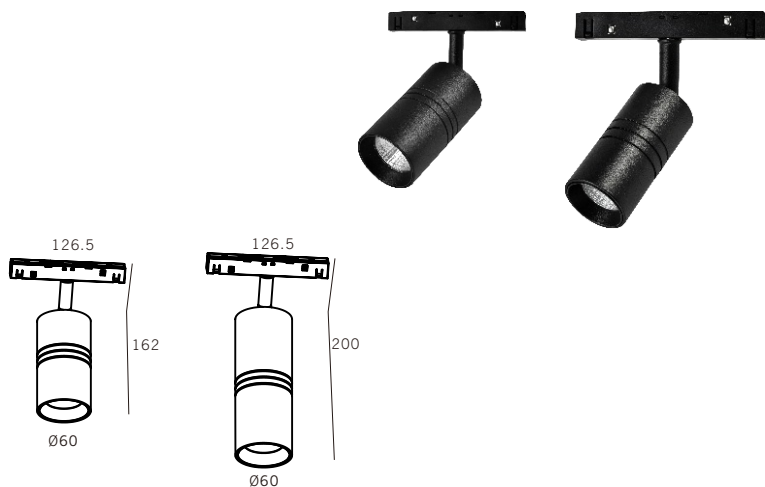

Product Code	Watt	CCT	>CRI	Voltage	LUMEN	Product Size	Finish	System Options
R20-MS01-15	15W	3/4/5000K	Ra90	48V	1200lm	Ø60x162x126.5	■ BK	No Dim, Dali,
R20-MS01-20	20W	3/4/5000K	Ra90	48V	1600lm	Ø60x200x126.5	□ WH ■ BR	0-10V, Bluetooth, Zigbee

Beam angle

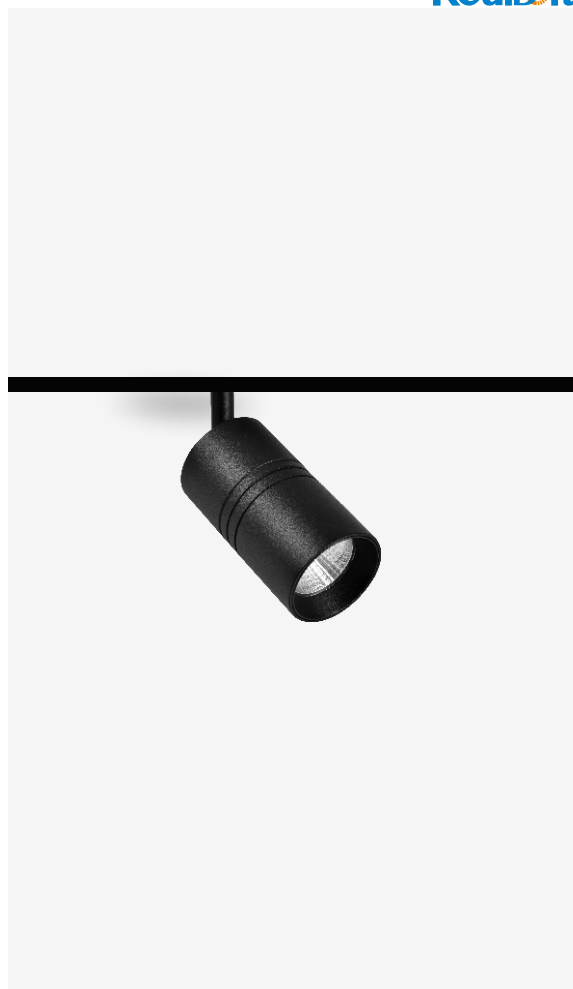
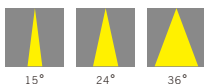

R20-MS04-12/20/30

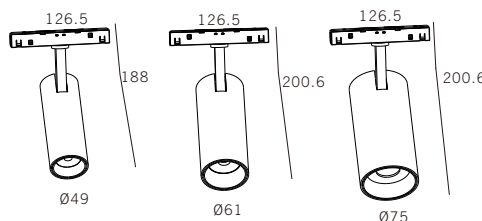

Product Code	Watt	CCT	>CRI	Voltage	LUMEN	Product Size	Finish	System Options
R20-MS04-12	12W	3/4/5000K	Ra90	48V	960lm	Ø49x188x126.5	■ BK	No Dim, Dali,
R20-MS04-20	20W	3/4/5000K	Ra90	48V	1600lm	Ø61x200.6x126.5	□ WH	0-10V, Bluetooth, Zigbee
R20-MS04-30	30W	3/4/5000K	Ra90	48V	2400lm	Ø75x200.6x126.5	■ BR	

Beam angle

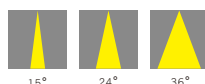

R20-MS02A/B/C-8/16/16

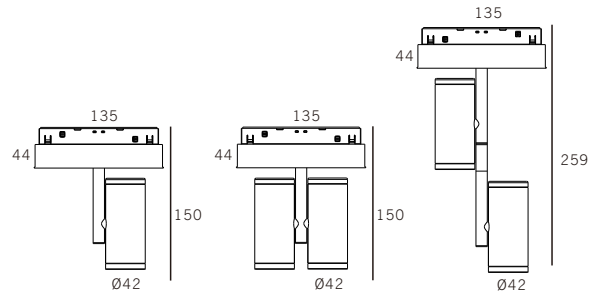
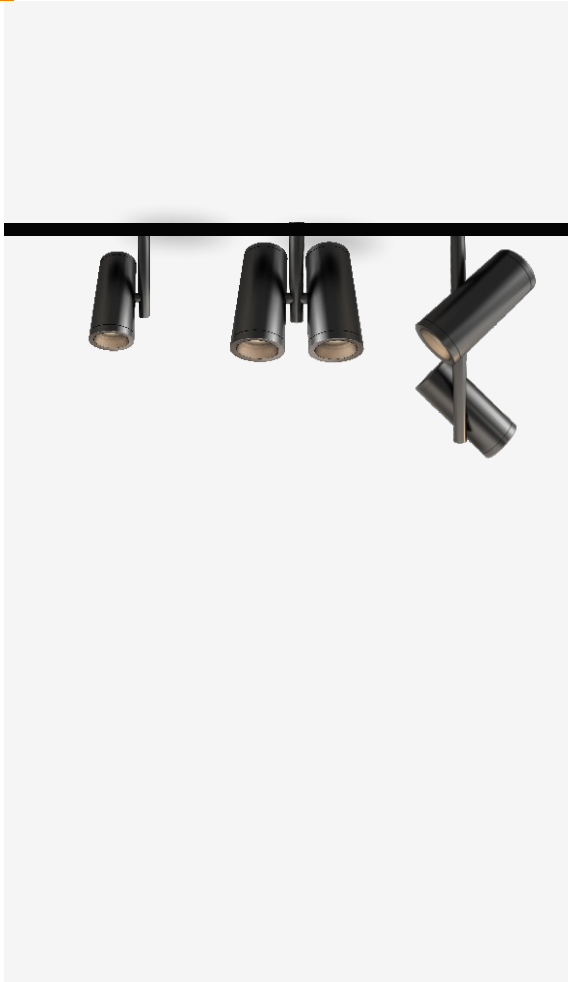

Product Code	Watt	CCT	>CRI	Voltage	LUMEN	Product Size	Finish	System Options
R20-MS02A-8	8W	3/4/5000K	Ra90	48V	540lm	Ø42x150x135	■ BK	No Dim, Dali, 0-10V, Bluetooth, Zigbee
R20-MS02B-16	16W	3/4/5000K	Ra90	48V	1440lm	Ø42x150x135	□ WH	
R20-MS02C-16	16W	3/4/5000K	Ra90	48V	1440lm	Ø42x259x135	■ BR	

Beam angle

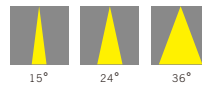

R20-MS03-12

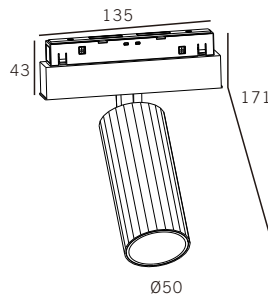

Product Code	Watt	CCT	>CRI	Voltage	LUMEN	Product Size	Finish	System Options
R20-MS03-12	12W	3/4/5000K	Ra90	48V	860lm	Ø50x171x135	■ BK □ WH ■ BR	No Dim, Dali, 0-10V, Bluetooth, Zigbee, Mijia

Beam angle

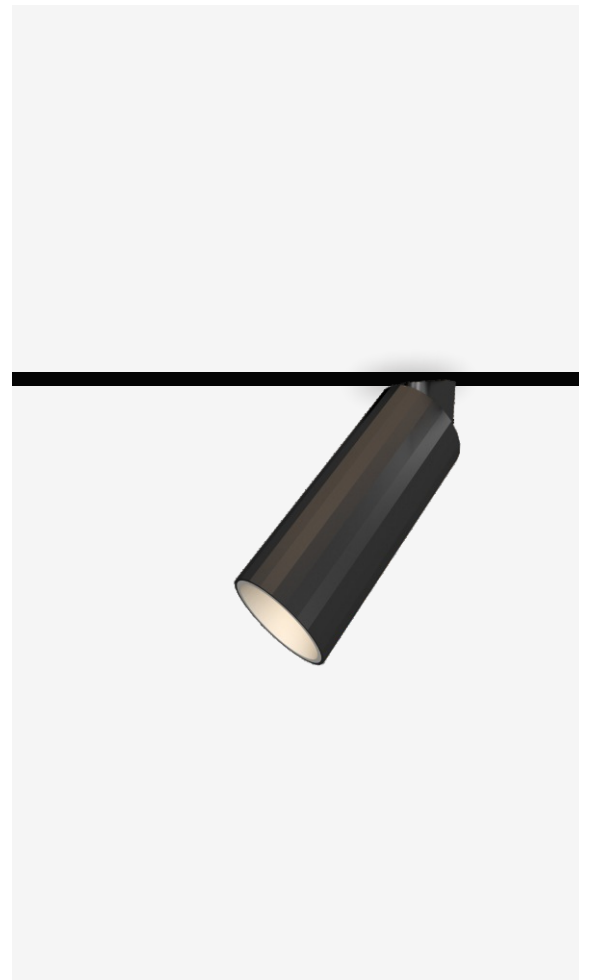

R20-MG01-6/12/18/24/36

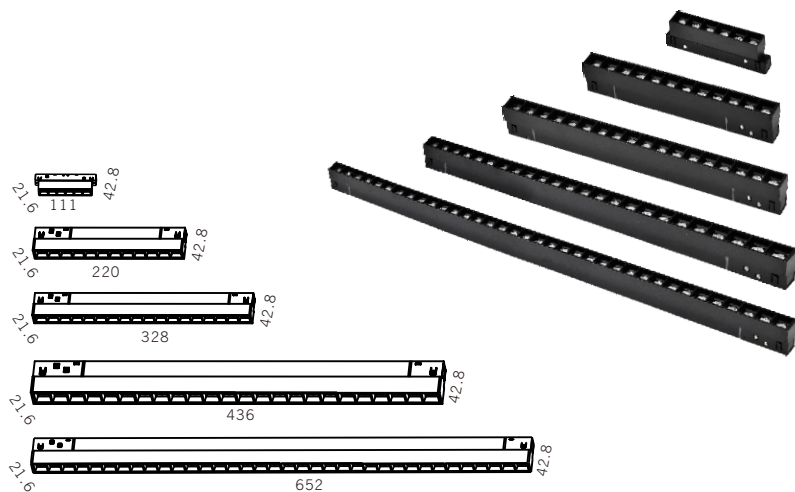

Product Code	Watt	CCT	>CRI	Voltage	LUMEN	Product Size	Finish	System Options
R20-MG01-6	6W	3/4/5000K	Ra90	48V	480lm	111x21.6x42.8	■ BK	No Dim,
R20-MG01-12	12W	3/4/5000K	Ra90	48V	960lm	220x21.6x42.8	□ WH	Dali,
R20-MG01-18	18W	3/4/5000K	Ra90	48V	1440lm	328x21.6x42.8		0-10V,
R20-MG01-24	24W	3/4/5000K	Ra90	48V	1920lm	436x21.6x42.8		Bluetooth,
R20-MG01-36	36W	3/4/5000K	Ra90	48V	2880lm	652x21.6x42.8		Zigbee

Beam angle

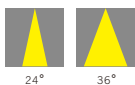

R20-MG02-12

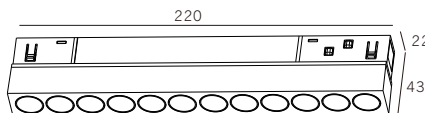
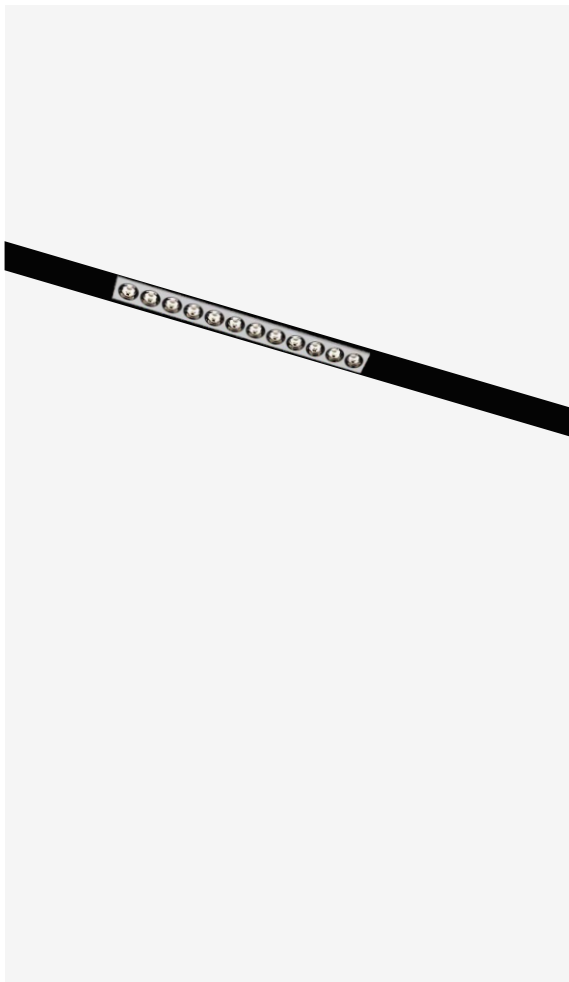

Product Code	Watt	CCT	>CRI	Voltage	LUMEN	Product Size	Finish	System Options
R20-MG02-12	12W	3/4/5000K	Ra90	48V	960lm	220x22x43	■ BK □ WH	No Dim, Dali, 0-10V, Bluetooth, Zigbee

Beam angle



R20-MXG01-6/12

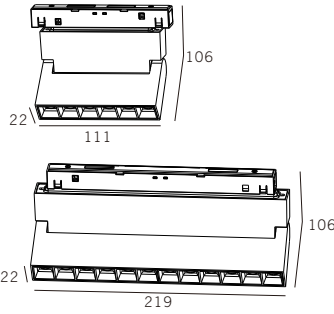

Product Code	Watt	CCT	>CRI	Voltage	LUMEN	Product Size	Finish	System Options
R20-MXG01-6	6W	3/4/5000K	Ra90	48V	480lm	111x22x106	■ BK	No Dim, Dali, 0-10V, Bluetooth, Zigbee
R20-MXG01-12	12W	3/4/5000K	Ra90	48V	960lm	219x22x106	□ WH	

Beam angle

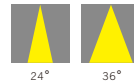

R20-MXF01-6/12

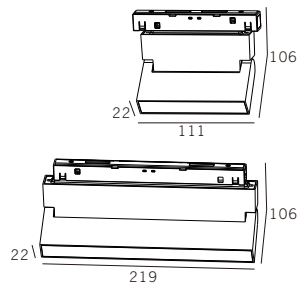

Product Code	Watt	CCT	>CRI	Voltage	LUMEN	Product Size	Finish	System Options
R20-MXF01-6	6W	3/4/5000K	Ra90	48V	420lm	111x22x106	■ BK	No Dim, Dali, 0-10V, Bluetooth, Zigbee
R20-MXF01-12	12W	3/4/5000K	Ra90	48V	840lm	219x22x106	□ WH	

Beam angle



R20-MXG02-12

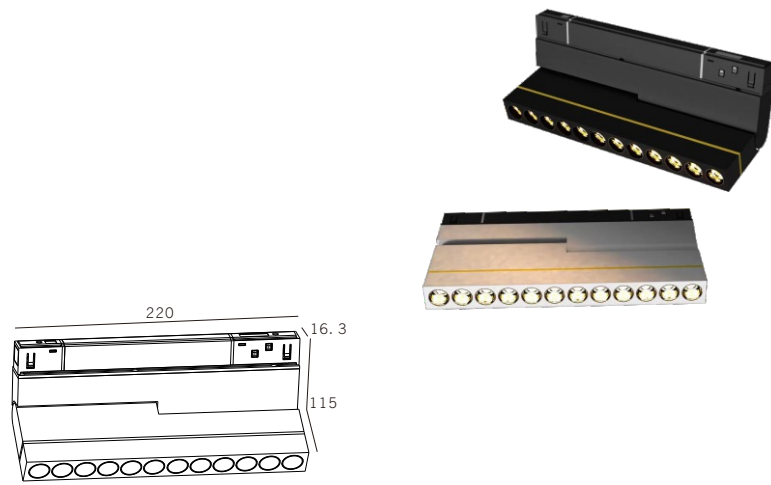

Product Code	Watt	CCT	>CRI	Voltage	LUMEN	Product Size	Finish	System Options
R20-MXG02-12	12W	3/4/5000K	Ra90	48V	960lm	220x16.3x115	<input checked="" type="checkbox"/> BK <input type="checkbox"/> WH	No Dim, Dali, 0-10V, Bluetooth, Zigbee

Beam angle

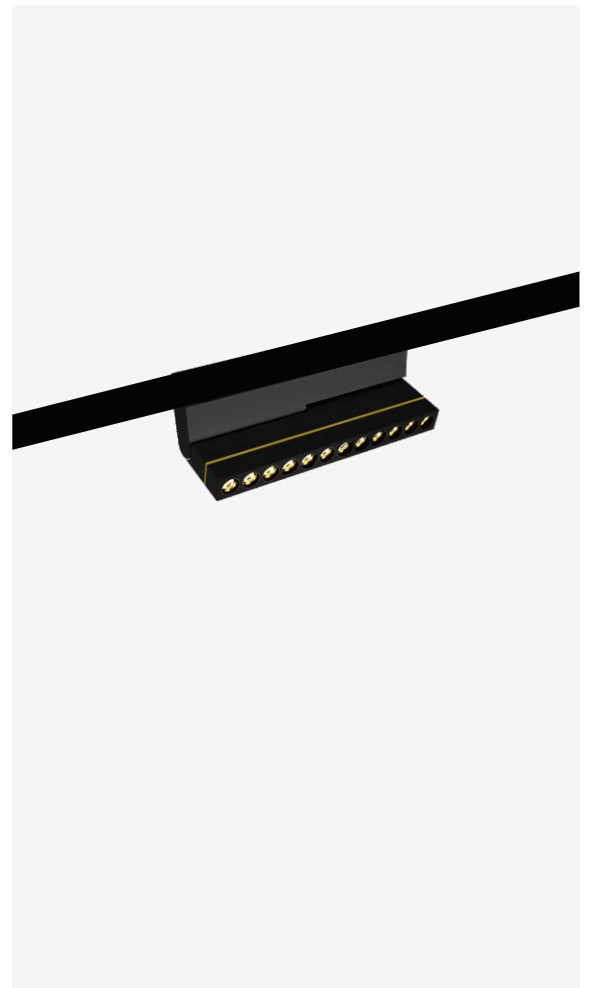

R20-MDB01/02-12

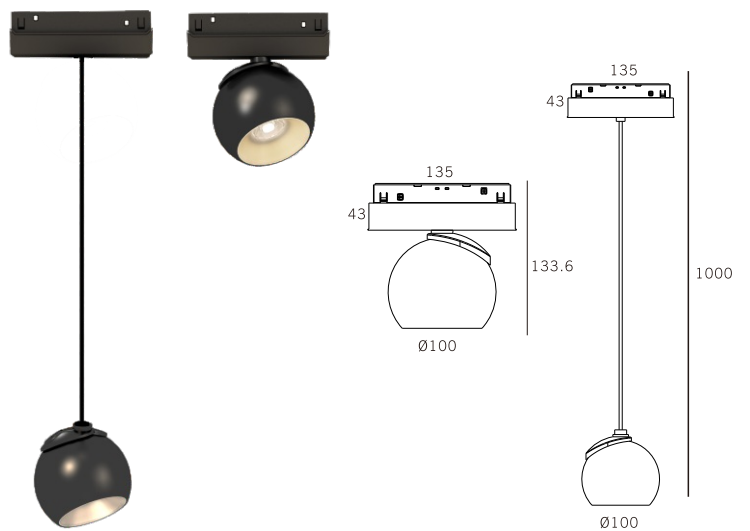

Product Code	Watt	CCT	>CRI	Voltage	LUMEN	Product Size	Finish	System Options
R20-MDB01-12	12W	3/4/5000K	Ra90	48V	960lm	Ø100x133.6x135	<input checked="" type="checkbox"/> BK	No Dim, Dali, 0-10V, Bluetooth, Zigbee
R20-MDB02-12	12W	3/4/5000K	Ra90	48V	960lm	Ø100x1000x135	<input type="checkbox"/> WH <input checked="" type="checkbox"/> GD	

Beam angle

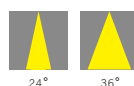

R20-MDR01(02)-10

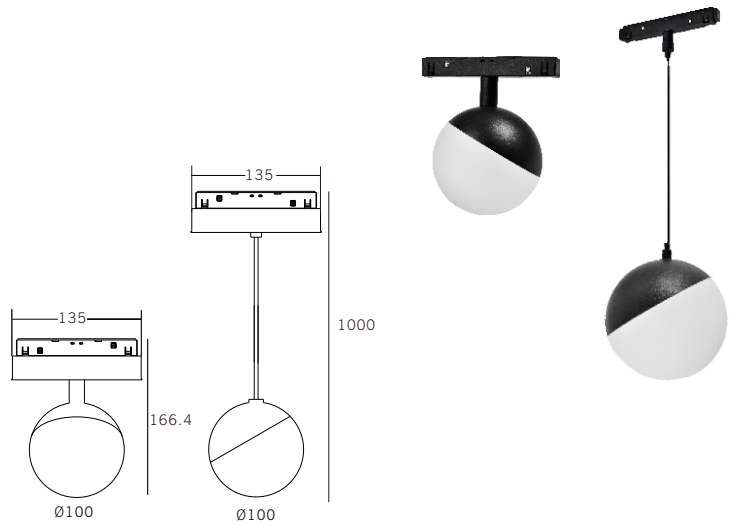
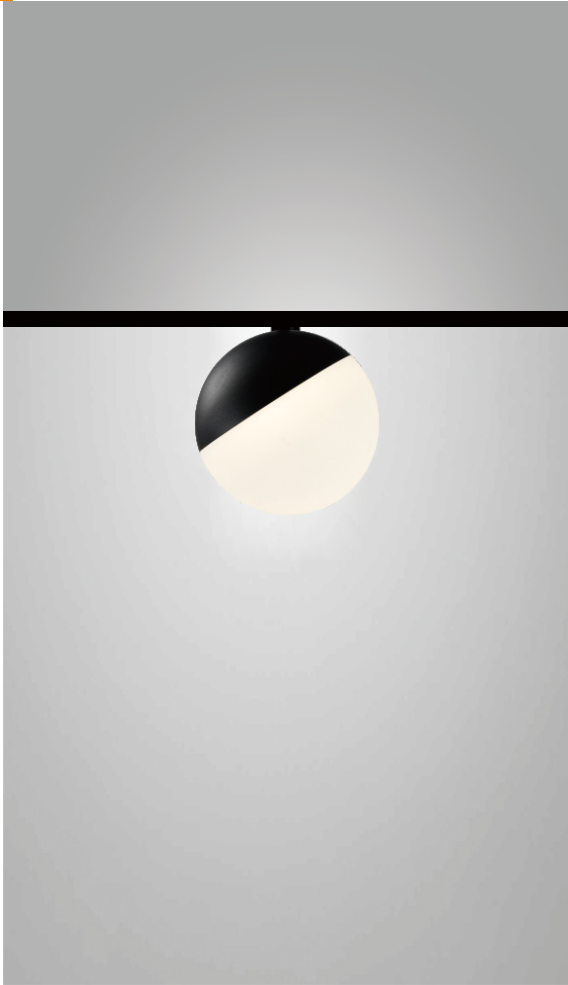

Product Code	Watt	CCT	>CRI	Voltage	LUMEN	Product Size	Finish	System Options
R20-MDR01-10	10W	3/4/5000K	Ra90	48V	800lm	Ø100x166.4x135	■ BK	No Dim, Dali, 0-10V, Bluetooth, Zigbee
R20-MDR02-10	10W	3/4/5000K	Ra90	48V	800lm	Ø100x1000x135	□ WH	

Beam angle



134°

R20-MDT01-9

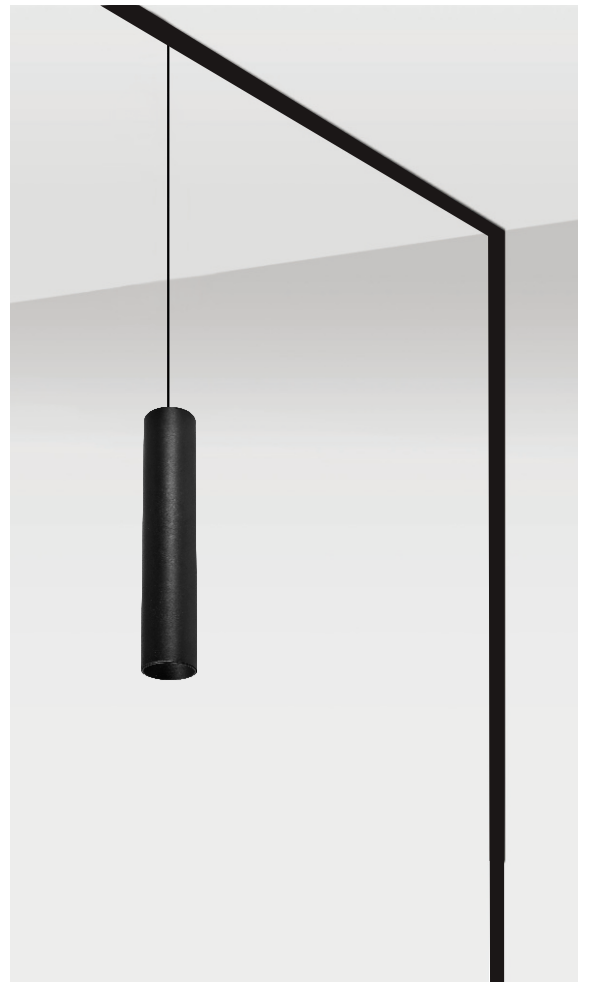
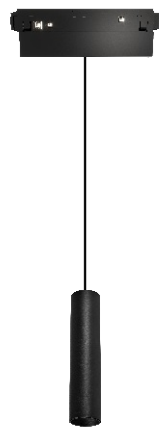
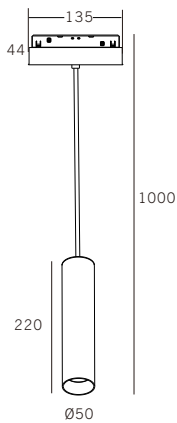

Product Code	Watt	CCT	>CRI	Voltage	LUMEN	Product Size	Finish	System Options
R20-MDT01-9	9W	3/4/5000K	Ra90	48V	720lm	Ø50x1000x135	■ BK □ WH	No Dim, Dali, 0-10V, Bluetooth, Zigbee, Mijia

Beam angle

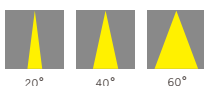

R20-MML-25/30/35 MJL-40/45

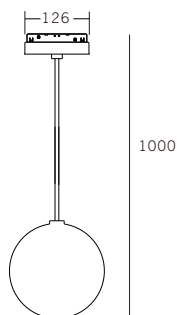

Ø250/300/350/400/450mm

Product Code	Watt	CCT	> CRI	Voltage	LUMEN	Product Size	Material	Finish
R20-MML-25/30/35	24W	3/4000K	Ra80	48V	800lm	Ø250/300mm	PLA	<input type="checkbox"/> WH
R20-MJL-40/45	24W	3/4000K	Ra80	48V	800lm	Ø350/400/450mm	PLA	<input type="checkbox"/> WH

Beam angle



240°

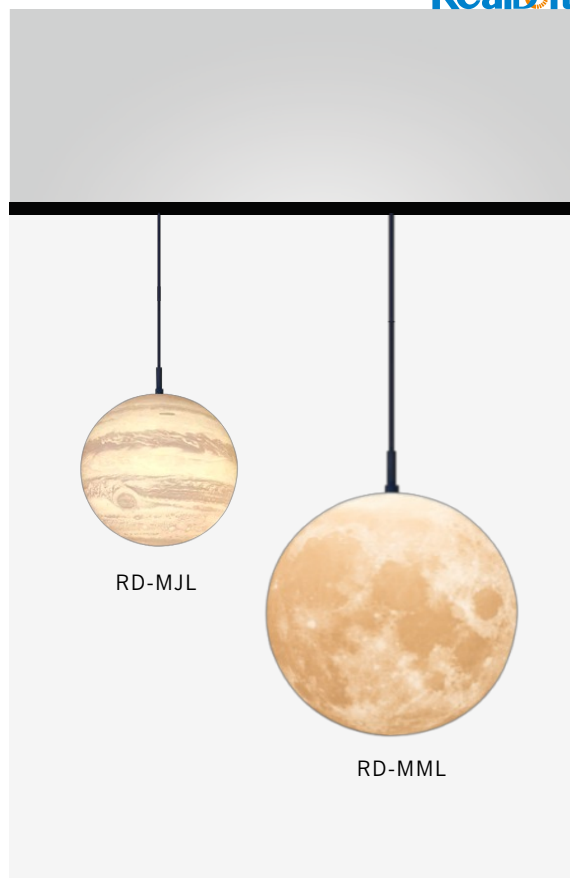

RD-MJL

RD-MML



R20-Track

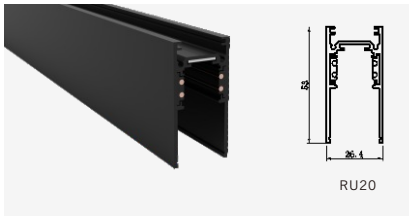

RU20
Size : 26.4X53mm



RU20-1
Size : 26.4X78.4mm

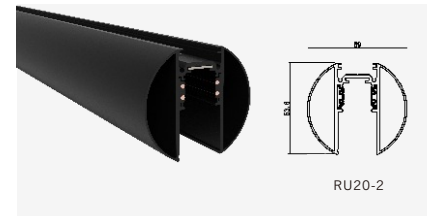

RU20-2
Size : 59X53.6mm

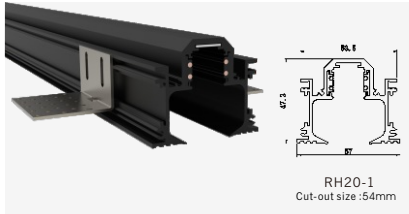

RH20-1
Size : 53.5X47.3X57mm

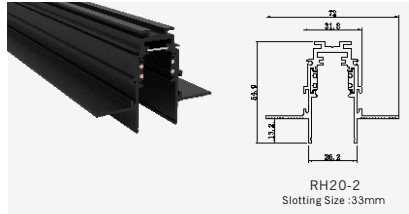

RH20-2
Size : 72X54.9X26.3mm

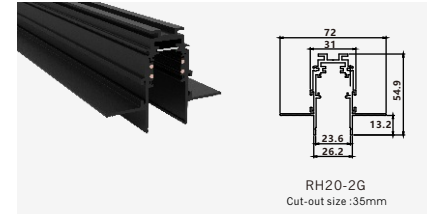

RH20-2G
Size : 31X53X72mm



RH20-4
Size : 32X56.3X42mm

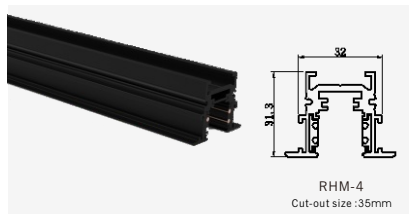

RHM-4
Size : 31.3X32X42mm

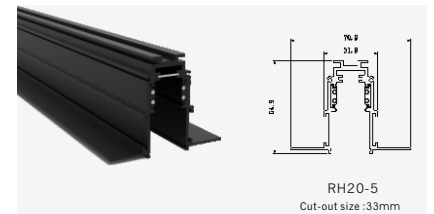

RH20-5
Size : 70.9X54.9X31.8mm

R20-Parts

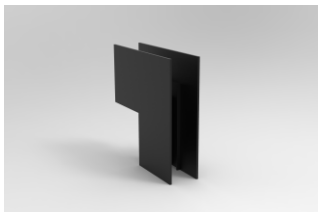

RU20
External Vertical Corner Joint

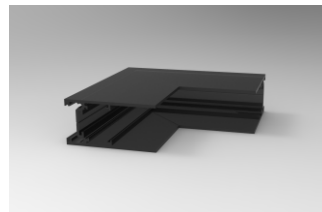

RU20
Internal Vertical Corner Joint

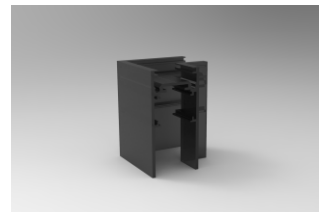

RU20
Corner joint

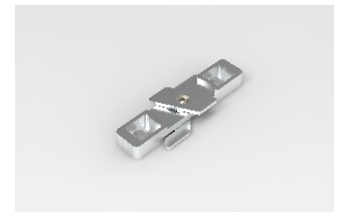

RU20
Suspension bracket

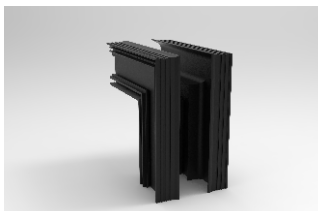

RH20-1
External Vertical Corner Joint

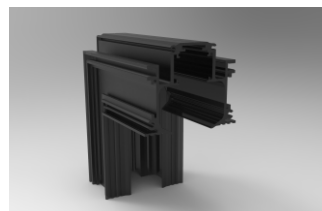

RH20-1
Internal Vertical Corner Joint

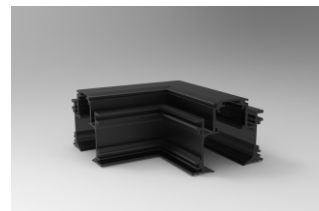

RH20-1
Corner joint



RH20
L bracket

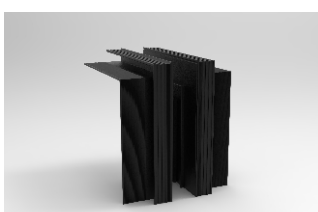

RH20-2
External Vertical Corner Joint

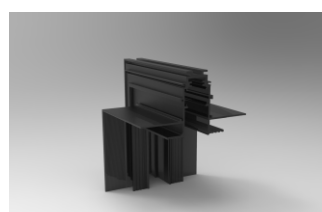

RH20-2
Internal Vertical Corner Joint

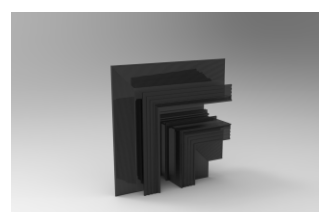

RH20-2
Corner joint



RH20
BRACKET WITH SPRING L BRACKET

CONNENTION MODULE



90° connection



Connection



Adaptor



Straight connection



Live end

48V POWER SUPPLY

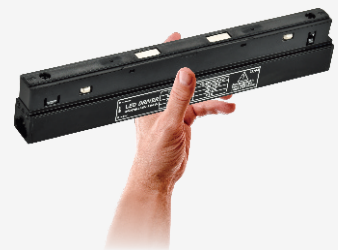

Magnetic support
Easy to position and re-position

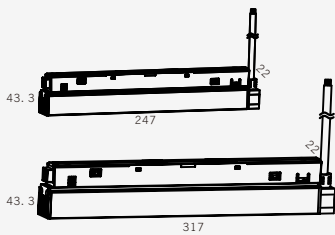

Product Code	Watt	Product Size	Finish	Warranties
R20-P100	100W	247x43. 3x22	■ BK	2 years
R20-P200	200W	247x43. 3x22	□ WH	2 years

