

STREET LIGHT SERIES



LED STREET LIGHT



RL02 SERIES

30W 50W 100W 150W 200W



STREET LIGHT SERIES

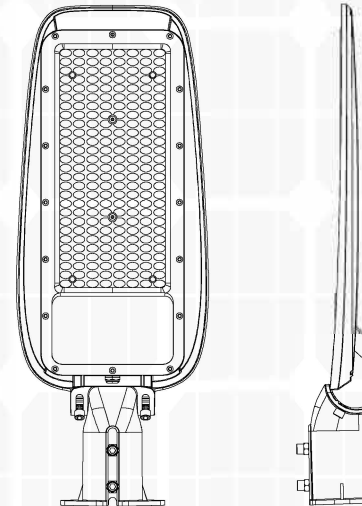

PRODUCT ADVANTAGES AND FEATURES

- Integrated cooling design, elegant, efficient
- Streamline design, beautiful appearance, no accumulation
- ADC12# die-casting aluminum case, excellent heat dissipation performance, durable
- Professional outdoor painting, stainless steel components, excellent anti-corrosion and anti-rusting performance, widely used in different environment
- Light transmittance up to 94%, easy to improve in the future



Product Technical Parameters

Model	Luminous	Power factor	SPD
RL02 30W	100-120lm/W	>0.9	>6KV
RL02 50W	100-120lm/W	>0.9	>6KV
RL02 100W	100-120lm/W	>0.9	>8KV
RL02 150W	100-120lm/W	>0.9	>10KV
RL02 200W	100-120lm/W	>0.9	>10KV

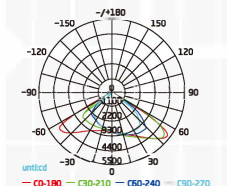

100W-Light Distribution Curve

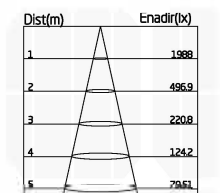

100W-Lux Distance Curve

LED STREET LIGHT



RX02 SERIES

30W 50W 100W 150W 200W



STREET LIGHT SERIES

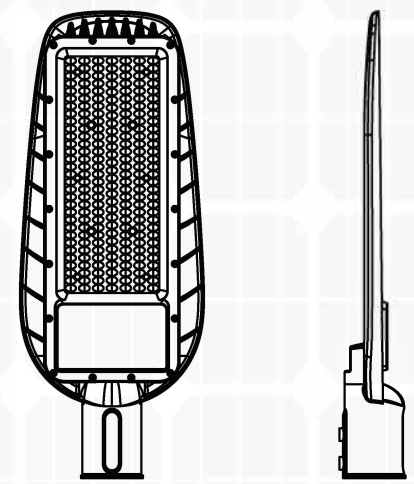

PRODUCT ADVANTAGES AND FEATURES

- Integrated cooling design, elegant, efficient
- Streamline design, beautiful appearance, no accumulation
- ADC12# die-casting aluminum case, excellent heat dissipation performance, durable
- Professional outdoor painting, stainless steel components, excellent anti-corrosion and anti-rusting performance, widely used in different environment
- Light transmittance up to 94%, easy to improve in the future



Product Technical Parameters

Model	Luminous	Power factor	SPD
RX02 30W	130-150lm/W	>0.9	>6KV
RX02 50W	130-150lm/W	>0.9	>6KV
RX02 100W	130-150lm/W	>0.9	>8KV
RX02 150W	130-150lm/W	>0.9	>10KV
RX02 200W	130-150lm/W	>0.9	>10KV

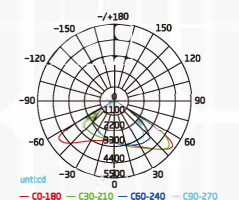

150W-Light Distribution Curve

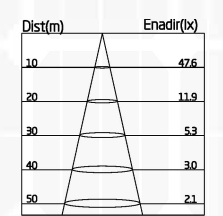

150W-Lux Distance Curve

LED STREET LIGHT



R SERIES
50



SOLAR FLOOD LIGHT SERIES

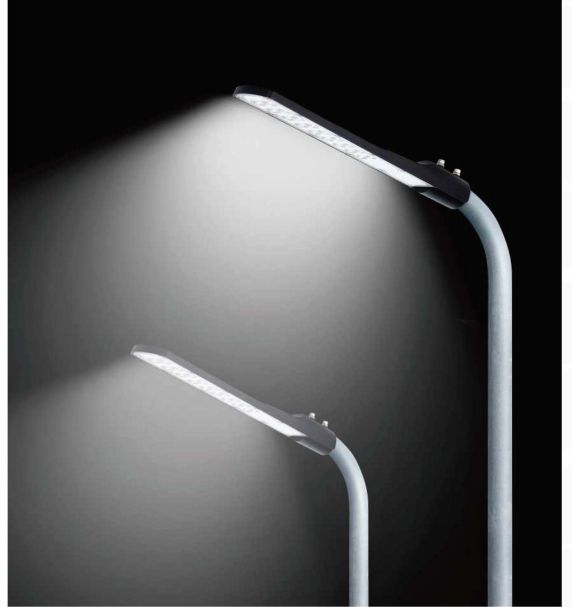
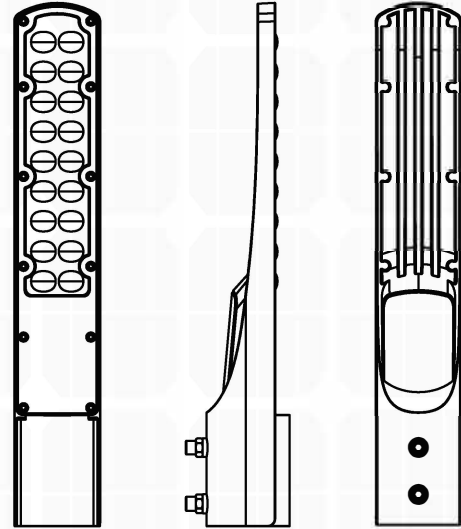

PRODUCT ADVANTAGES AND FEATURES

- Integrated cooling design, elegant, efficient
- Streamline design, beautiful appearance, no accumulation
- ADC12# die-casting aluminum case, excellent heat dissipation performance, durable
- Professional outdoor painting, stainless steel components, excellent anti-corrosion and anti-rusting performance, widely used in different environment
- Light transmittance up to 94%, easy to improve in the future



Product Technical Parameters

Model	Luminous	Power factor	SPD
R 50W	100-120lm/W	>0.9	>6KV

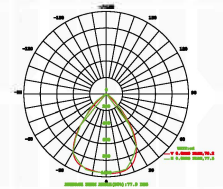

100W-Light Distribution Curve

Dist(m)	Enadir(lx)
1	3450
2	863
3	385
4	216
5	138

100W-Lux Distance Curve

LED STREET LIGHT



RL SERIES

30W 50W 100W 150W 200W



STREET LIGHT SERIES

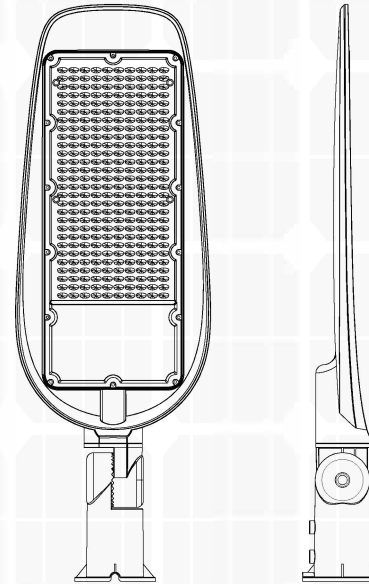

PRODUCT ADVANTAGES AND FEATURES

- Integrated cooling design, elegant, efficient
- Streamline design, beautiful appearance, no accumulation
- ADC12# die-casting aluminum case, excellent heat dissipation performance, durable
- Professional outdoor painting, stainless steel components, excellent anti-corrosion and anti-rusting performance, widely used in different environment
- Light transmittance up to 94%, easy to improve in the future



Product Technical Parameters

Model	Luminous	Power factor	SPD
RL 30W	100-120lm/W	>0.9	>6KV
RL 50W	100-120lm/W	>0.9	>6KV
RL 100W	100-120lm/W	>0.9	>8KV
RL 150W	100-120lm/W	>0.9	>10KV
RL 200W	100-120lm/W	>0.9	>10KV

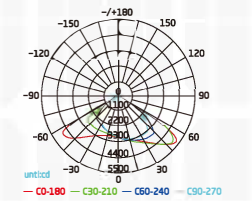

150W-Light Distribution Curve

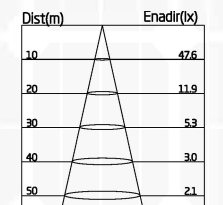

150W-Lux Distance Curve

LED STREET LIGHT



RX SERIES

50W 100W 150W 200W



STREET LIGHT SERIES

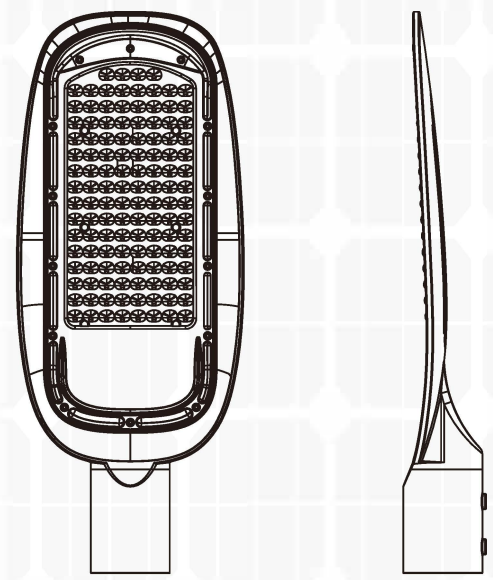

PRODUCT ADVANTAGES AND FEATURES

- Integrated cooling design, elegant, efficient
- Streamline design, beautiful appearance, no accumulation
- ADC12# die-casting aluminum case, excellent heat dissipation performance, durable
- Professional outdoor painting, stainless steel components, excellent anti-corrosion and anti-rusting performance, widely used in different environment
- Light transmittance up to 94%, easy to improve in the future



Product Technical Parameters

Model	Luminous	Power factor	SPD
RX 50W	100-120lm/W	>0.9	>6KV
RX 100W	100-120lm/W	>0.9	>8KV
RX 150W	100-120lm/W	>0.9	>10KV
RX 200W	100-120lm/W	>0.9	>10KV

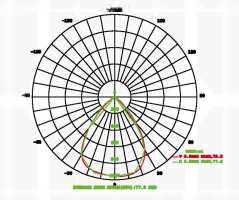

100W-Light Distribution Curve

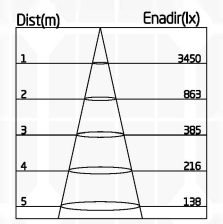

100W-Lux Distance Curve

LED STREET LIGHT



RE SERIES

30W 50W 100W 150W 200W



STREET LIGHT SERIES

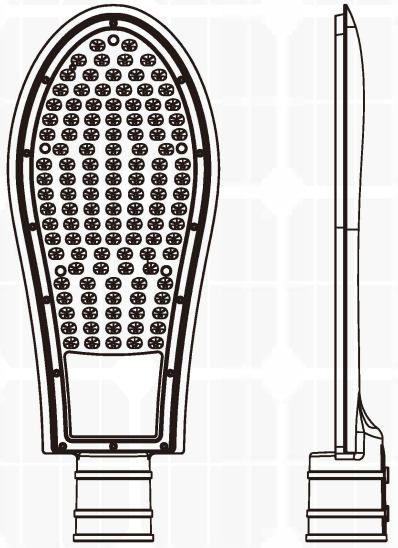

PRODUCT ADVANTAGES AND FEATURES

- Integrated cooling design, elegant, efficient
- Streamline design, beautiful appearance, no accumulation
- ADC12# die-casting aluminum case, excellent heat dissipation performance, durable
- Professional outdoor painting, stainless steel components, excellent anti-corrosion and anti-rusting performance, widely used in different environment
- Light transmittance up to 94%, easy to improve in the future



Product Technical Parameters

Model	Luminous	Power factor	SPD
RE 30W	130-150lm/W	>0.9	>6KV
RE 50W	130-150lm/W	>0.9	>6KV
RE 100W	130-150lm/W	>0.9	>8KV
RE 150W	130-150lm/W	>0.9	>10KV
RE 200W	130-150lm/W	>0.9	>10KV

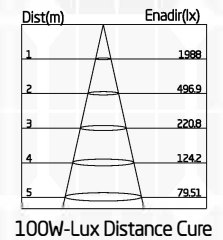
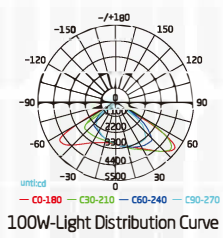

LED STREET LIGHT



RD SERIES

30W 50W 100W 150W 200W



STREET LIGHT SERIES

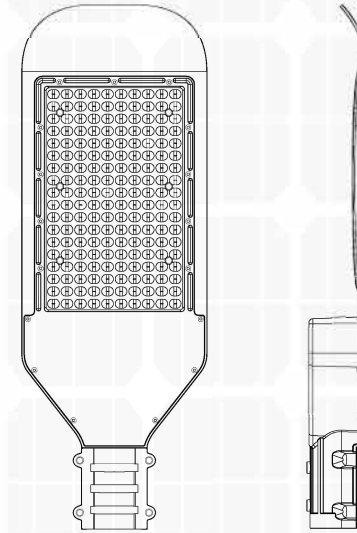

PRODUCT ADVANTAGES AND FEATURES

- Integrated cooling design, elegant, efficient
- Streamline design, beautiful appearance, no accumulation
- ADC12# die-casting aluminum case, excellent heat dissipation performance, durable
- Professional outdoor painting, stainless steel components, excellent anti-corrosion and anti-rusting performance, widely used in different environment
- Light transmittance up to 94%, easy to improve in the future



Product Technical Parameters

Model	Luminous	Power factor	SPD
RD 30W	130-150lm/W	>0.9	>6KV
RD 50W	130-150lm/W	>0.9	>6KV
RD 100W	130-150lm/W	>0.9	>8KV
RD 150W	130-150lm/W	>0.9	>10KV
RD 200W	130-150lm/W	>0.9	>10KV

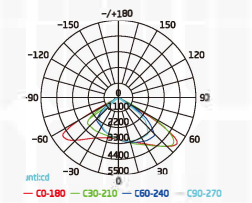

150W-Light Distribution Curve

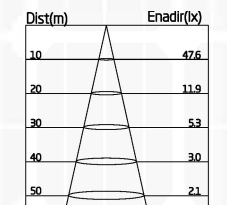

150W-Lux Distance Curve