



48V MAGNETIC TRACK SYSTEM 2023

About Us



Company Profile:

Established in Jan. 2010, We are a professional factory producing and exporting LED lighting for landscapes and others.

Slogan: Realdo is really reliable

Mission: Providing entire and solely high-level and cost-effective LED lighting.

Reputation:

- * Getting full approval on ETL,UL,JA8(TITLE 24),FCC,CE,ErP,INMETRO,SAA,TUV,EMC,etc. to ensure product standard
- * Passing the audit for ISO9001, ISO14001, BSCI by SGS to build a responsible system to society, staffs and product quality.
- * Having obtained many PATENTS to provide unique and customized products to customers.
- * Exporting to more than 70 countries during the past 10 years to accumulate enough sales and service experiences for different markets and clients.



Product Catalogue



R15 03



R15 Flood light 05



R15 Spot light 06



R15-Gille light 09



R15 Folding light 09



R15 Suspension light 10

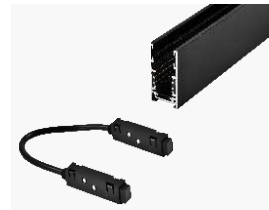

R15 Track & Modular 11



R20 12



R20 CCT adjust 14



R20 Flood light 15



R20 Spotlight 17



R20 Grill light 20



R20 Folding light 21



R20 Suspension light 22



R20 Lunar lamp 24



R20 Track 25

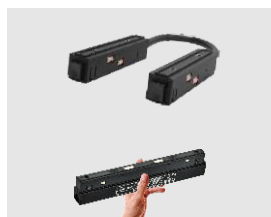

R20 Modular & Driver 26



R35 27



R35 Spot light 29



R35 Grille light 30



R35 Flood light 30



R35 Folding light 31



R35 Modular & Driver 31



R35 Track 32



↑
Magnetic installation easy and firm
↓



Magnetic track light simplify your life

- Adopts Modules concept, allowing the magnetic track system adapt to any changes in the space;
- Tool free installation; positioned and re-positioned the magnetic modules conveniently;
- Choose from a variety of LED light modules to meet personalized solution;
- The number of light modules can be added or moved freely;
- Low voltage safe, no-touch hazard

Secure Locking Support

Equipped with mechanical lock to make sure the modules are secured to the track. Press the two side buttons to unlock the modules.





combined with the highest capacitance value and lowest ESR, make the magnetic driver have the characteristic of frequency stability and open-circuit failure mode, etc.

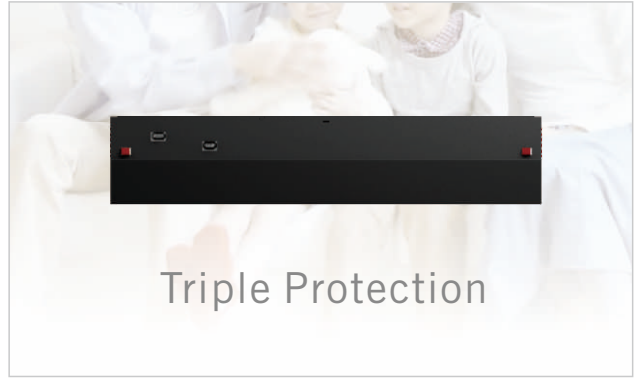

Short-circuit Protection

Over-load protection

over-voltage protection

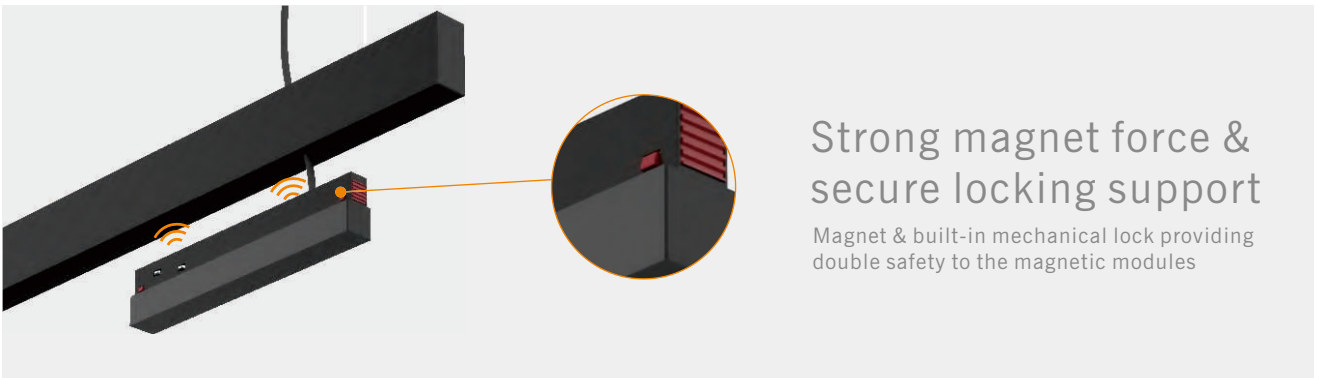



R15

MAGNETIC
TRACK LIGHT

Magnetic 15

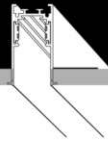

Recessed



Surface



Suspended

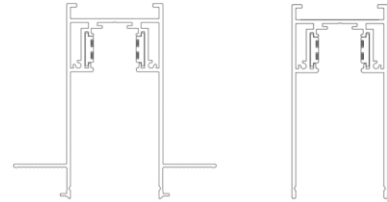

48V Magnetic Track System

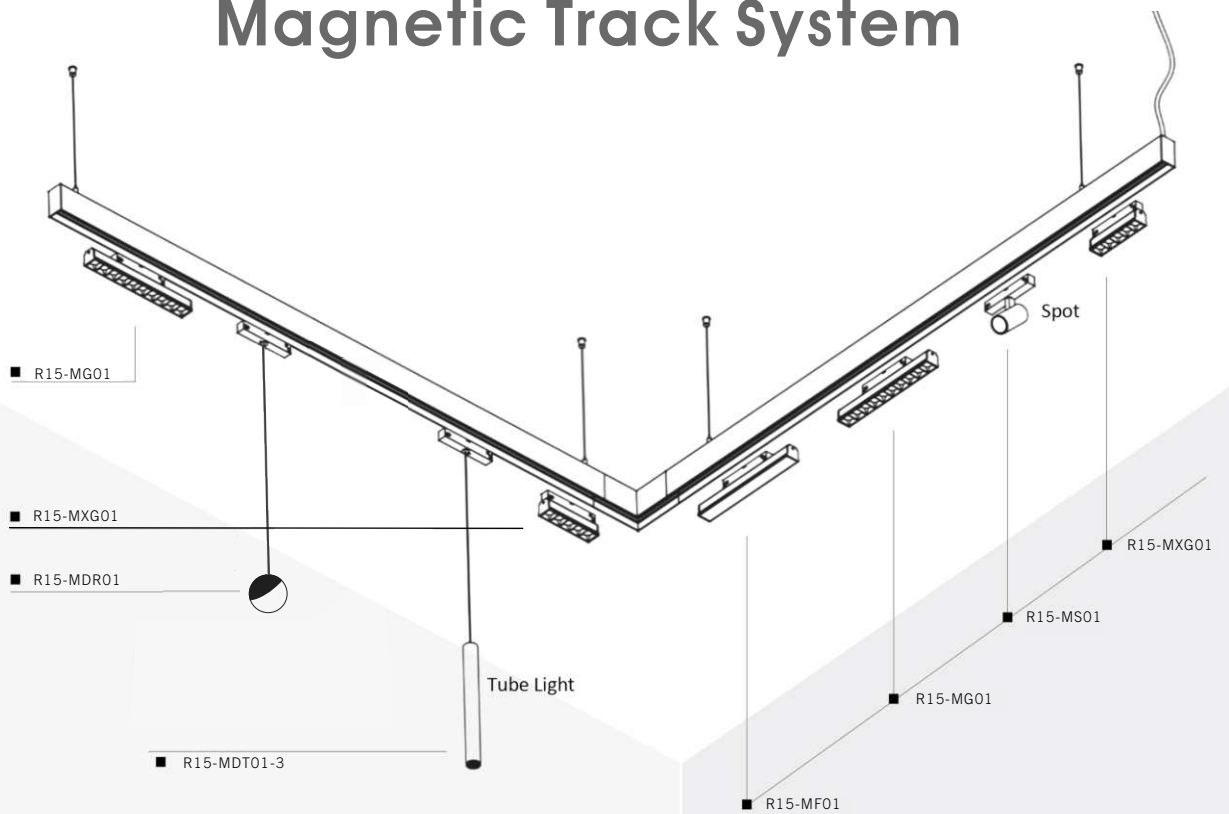

R15-MF01-10/20/30/40

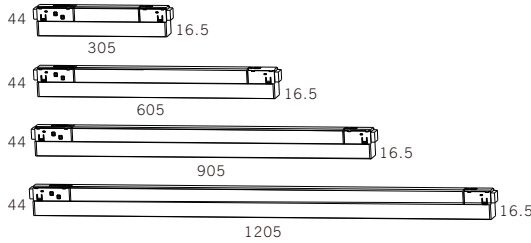

Product Code	Watt	CCT	>CRI	Voltage	LUMEN	Product Size	Finish	System Options
R15-MF01-10	10W	3/4/5000K	Ra90	48V	700lm	305x16.5x44	■ BK	No Dim, Dali, 0-10V, Bluetooth, Zigbee
R15-MF01-20	20W	3/4/5000K	Ra90	48V	1400lm	605x16.5x44	□ WH	
R15-MF01-30	30W	3/4/5000K	Ra90	48V	2100lm	905x16.5x44		
R15-MF01-40	40W	3/4/5000K	Ra90	48V	2800lm	1205x16.5x44		

Beam angle



R15-MF02-20D/IN

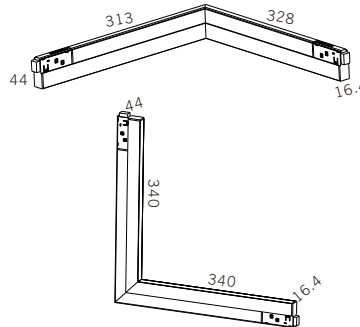

Product Code	Watt	CCT	>CRI	Voltage	LUMEN	Product Size	Finish	System Options
R15-MF02-20D	20W	3/4/5000K	Ra90	48V	1400lm	313x328x44	■ BK	No Dim, Dali, 0-10V, Bluetooth, Zigbee
R15-MF02-20IN	20W	3/4/5000K	Ra90	48V	1400lm	340x340x44	□ WH	

Beam angle



R15-MFT01-6/12

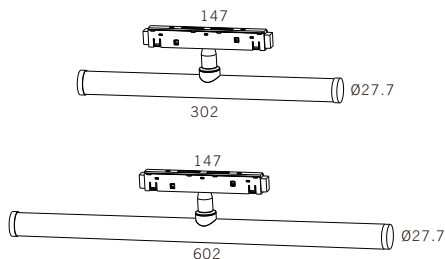
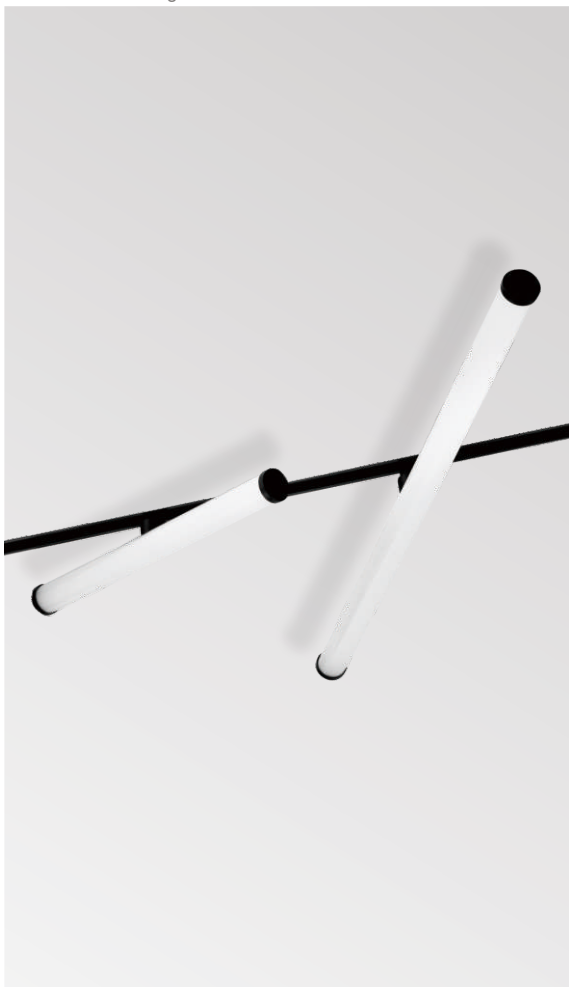

Product Code	Watt	CCT	>CRI	Voltage	LUMEN	Product Size	Finish	System Options
R15-MFT01-6	6W	3/4/5000K	Ra90	48V	600lm	302xØ27.7x147	■ BK	No Dim, Dali, 0-10V, Bluetooth, Zigbee
R15-MFT01-12	12W	3/4/5000K	Ra90	48V	1200lm	602xØ27.7x147	□ WH	

Beam angle



R15-MS03-12

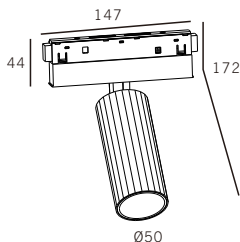

Product Code	Watt	CCT	>CRI	Voltage	LUMEN	Product Size	Finish	System Options
R15-MS03-12	12W	3/4/5000K	Ra90	48V	860lm	Ø50x172x147	■ BK □ WH ■ BR	No Dim, Dali, 0-10V, Bluetooth, Zigbee

Beam angle



R15-MS01-3/5

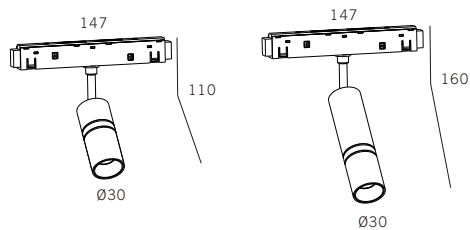
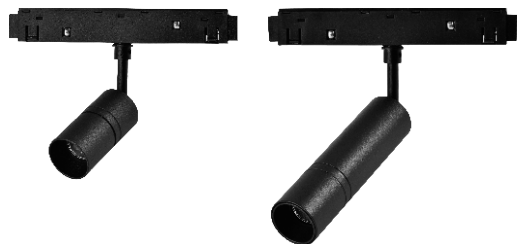

Product Code	Watt	CCT	>CRI	Voltage	LUMEN	Product Size	Finish	System Options
R15-MS01-3	3W	3/4/5000K	Ra90	48V	220lm	Ø30x110x147	■ BK	No Dim, Dali, 0-10V, Bluetooth, Zigbee
R15-MS01-5	5W	3/4/5000K	Ra90	48V	380lm	Ø30x160x147	□ WH ■ BR	

Beam angle

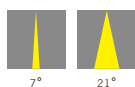

R15-MS01-7/12

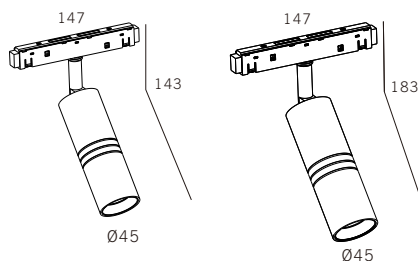

Product Code	Watt	CCT	>CRI	Voltage	LUMEN	Product Size	Finish	System Options
R15-MS01-7	7W	3/4/5000K	Ra90	48V	560lm	Ø45x143x147	■ BK	No Dim, Dali, 0-10V, Bluetooth, Zigbee
R15-MS01-12	12W	3/4/5000K	Ra90	48V	960lm	Ø45x183x147	□ WH ■ BR	

Beam angle

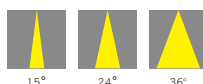

R15-MS01-16/20

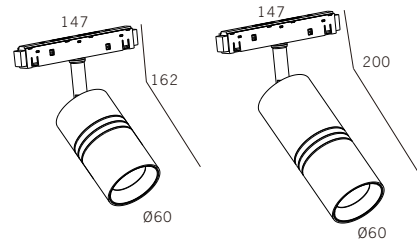

Product Code	Watt	CCT	>CRI	Voltage	LUMEN	Product Size	Finish	System Options
R15-MS01-16	16W	3/4/5000K	Ra90	48V	1280lm	Ø60x162x147	■ BK	No Dim, Dali, 0-10V, Bluetooth, Zigbee
R15-MS01-20	20W	3/4/5000K	Ra90	48V	1600lm	Ø60x200x147	□ WH ■ BR	

Beam angle

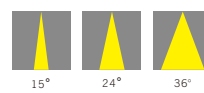

R15-MS02(A/B/C)-7/16

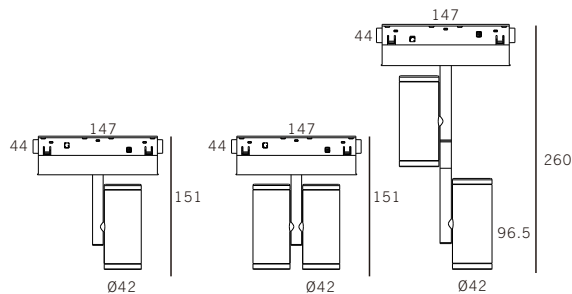

Product Code	Watt	CCT	>CRI	Voltage	LUMEN	Product Size	Finish	System Options
R15-MS02A-7	7W	3/4/5000K	Ra90	48V	560lm	Ø42x151x147	■ BK	No Dim, Dali, 0-10V, Bluetooth, Zigbee
R15-MS02B-16	16W	3/4/5000K	Ra90	48V	1440lm	Ø42x151x147	□ WH	
R15-MS02C-16	16W	3/4/5000K	Ra90	48V	1440lm	Ø42x260x147	■ BR	

Beam angle

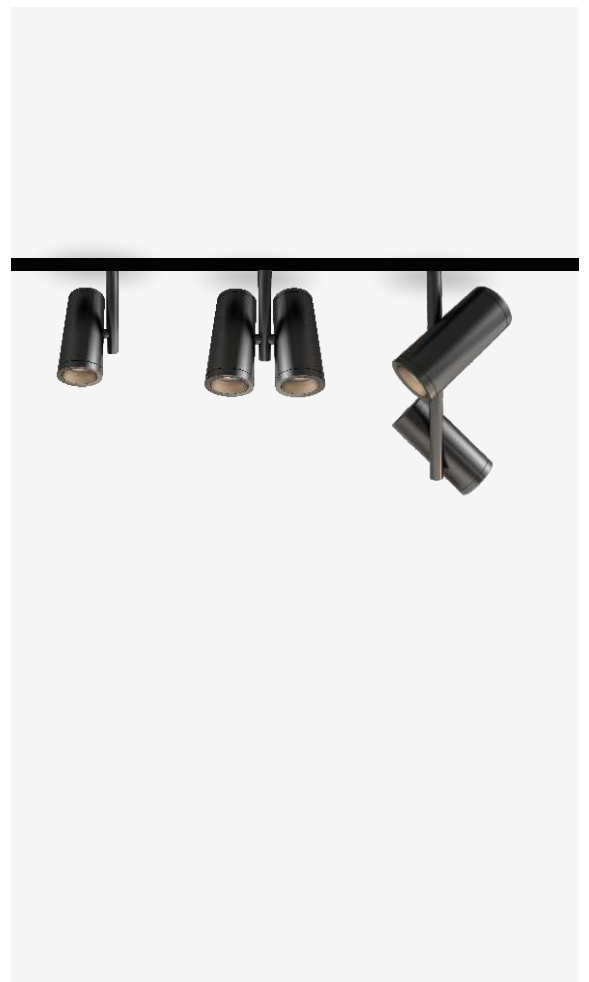
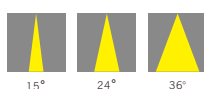

R15-MG01-12/18

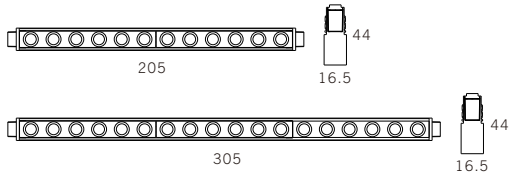

Product Code	Watt	CCT	>CRI	Voltage	LUMEN	Product Size	Finish	System Options
R15-MG01-12	12W	3/4/5000K	Ra90	48V	960lm	205x16.5x44	■ BK	No Dim, Dali, 0-10V, Bluetooth, Zigbee
R15-MG01-18	18W	3/4/5000K	Ra90	48V	1440lm	305x16.5x44	□ WH	

Beam angle

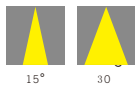

R15-MXG01-6/12

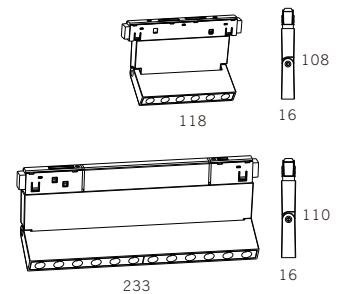

Product Code	Watt	CCT	>CRI	Voltage	LUMEN	Product Size	Finish	System Options
R15-MXG01-6	6W	3/4/5000K	Ra90	48V	480lm	118x16x108	■ BK	No Dim, Dali, 0-10V, Bluetooth, Zigbee
R15-MXG01-12	12W	3/4/5000K	Ra90	48V	960lm	233x16x110	□ WH	

Beam angle



R15-MDR01/02-10

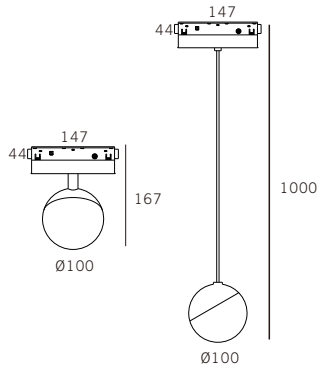

Product Code	Watt	CCT	>CRI	Voltage	LUMEN	Product Size	Finish	System Options
R15-MDR01-10	10W	3/4/5000K	Ra90	48V	800lm	Ø100x167x147	■ BK	No Dim, Dali, 0-10V, Bluetooth, Zigbee
R15-MDR02-10	10W	3/4/5000K	Ra90	48V	800lm	Ø100x1000x147	□ WH ■ GD	

Beam angle



R15-MDT01-9

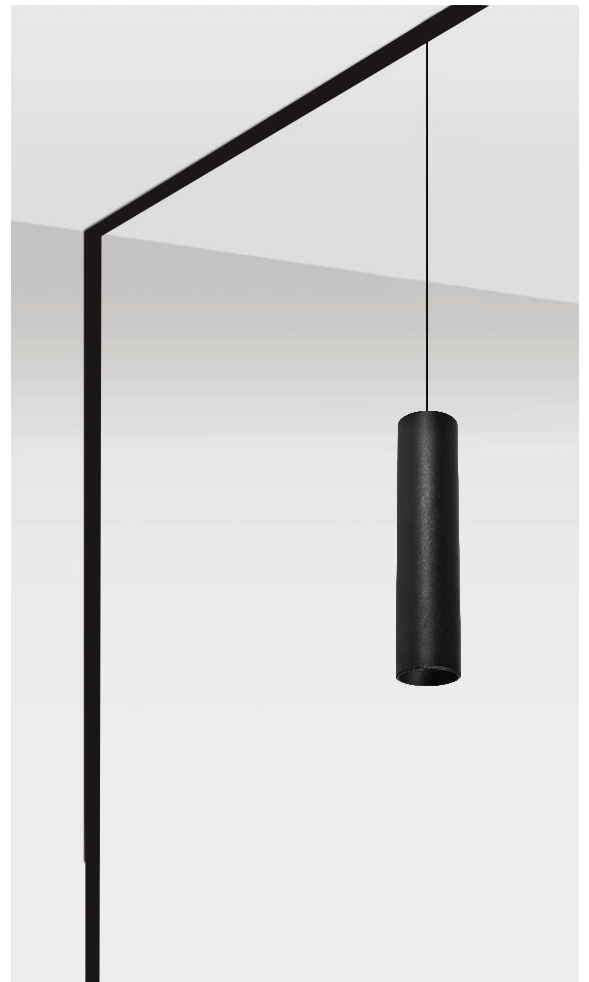
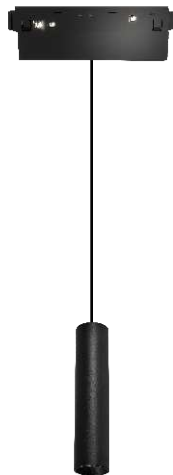
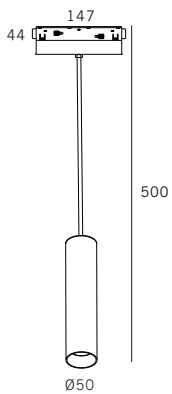

Product Code	Watt	CCT	>CRI	Voltage	LUMEN	Product Size	Finish	System Options
R15-MDT01-9	9W	3/4/5000K	Ra90	48V	720lm	Ø50x500x147	■ BK □ WH	No Dim, Dali, 0-10V, Bluetooth, Zigbee

Beam angle

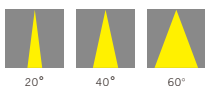

R15-MDB01/02-12

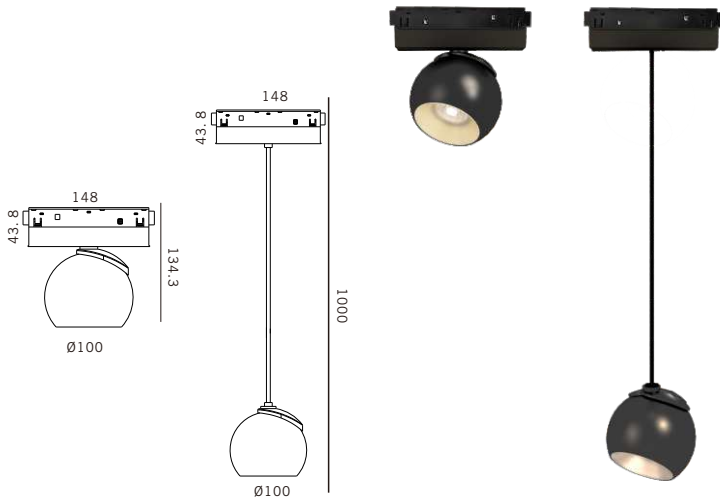

Product Code	Watt	CCT	>CRI	Voltage	LUMEN	Product Size	Finish	System Options
R15-MDB01-12	12W	3/4/5000K	Ra90	48V	960lm	Ø100x134.3x148	■ BK	No Dim, Dali, 0-10V, Bluetooth, Zigbee
R15-MDB02-12	12W	3/4/5000K	Ra90	48V	960lm	Ø100x1000x148	□ WH ■ GD	

Beam angle

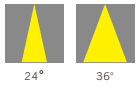

CONNENTION MODULE

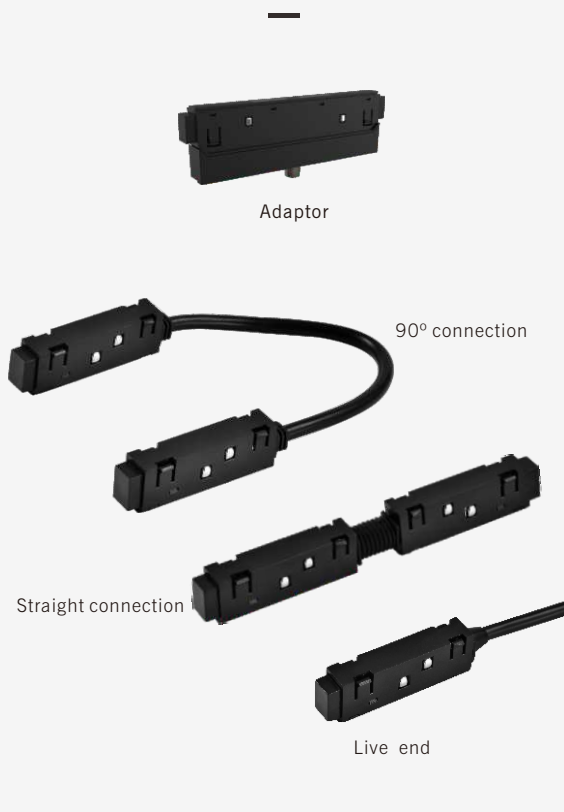

R15-Track

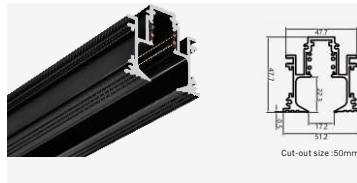

RH15-1
Size: L1000*W47.7*H47.7mm

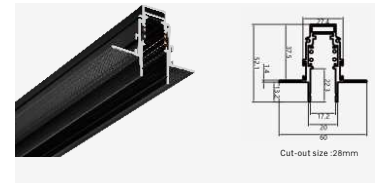

RH15-2S
Size: L1000*W60*H52.1mm

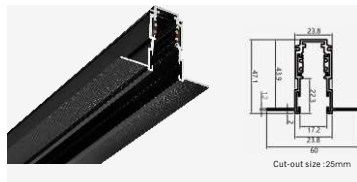

RH15-5
Size: L1000*W60*H47.1mm

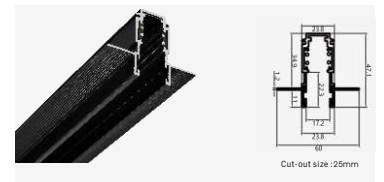

RH15-2A
Size: L1000*W60*H47.1mm

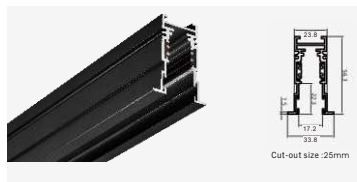

RH15-4
Size: L1000*W33.8*H56.3mm



RU15
Size: L1000*W24*H51.1mm



R20

MAGNETIC
TRACK LIGHT

Magnetic20

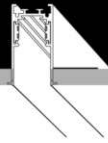

Recessed

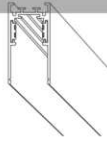

Surface

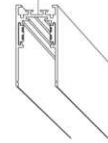

Suspended

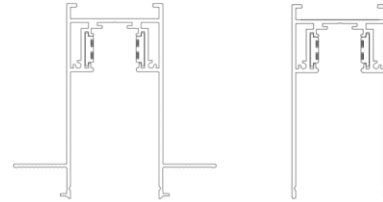

48V Magnetic Track System

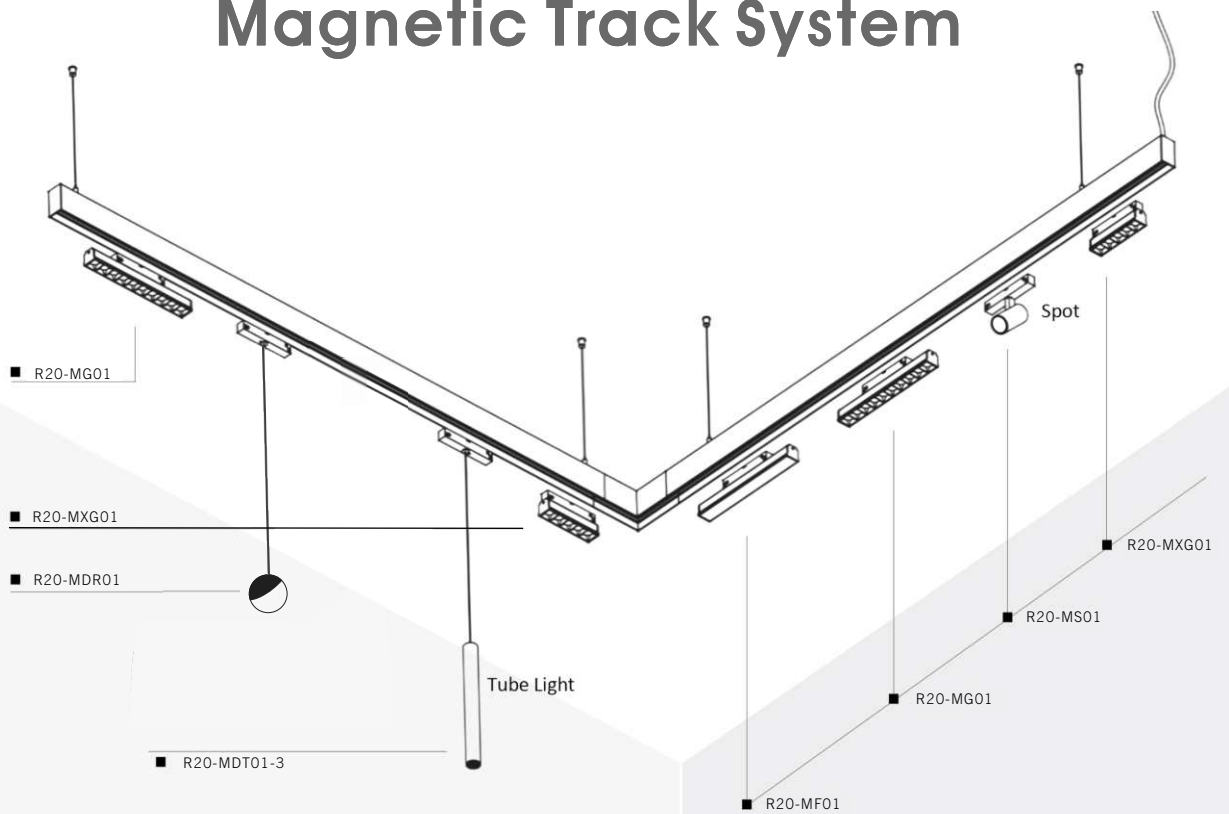

Realdot

MAGNETIC TRACK LIGHT



**CCT
ADJUST**

**ONE LIGHT
TAKES CARE OF EVERYTHING**

3000K-4000K-6000K
Toggle the switch to adjust the color temperature



One light takes care of everything

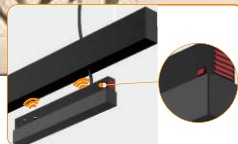

Strong magnet force & built-in lock



Magnetic installation easy and firm



Upgrade magnetic track rail



R20-MG02-6



R20-MG02-12



R20-MG02-18



R20-MDT02-9



R20-MF02-10



R20-MF02-20



R20-MXG02-6



R20-MXG02-12



R20-MXG02-18

R20-MF01-10/20/30/40

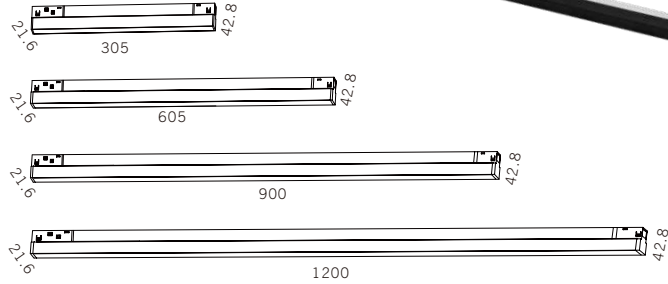

Product Code	Watt	CCT	>CRI	Voltage	LUMEN	Product Size	Finish	System Options
R20-MF01-10	10W	3/4/5000K	Ra90	48V	700lm	305x21.6x42.8	■ BK	No Dim, Dali,
R20-MF01-20	20W	3/4/5000K	Ra90	48V	1400lm	605x21.6x42.8	□ WH	0-10V, Bluetooth,
R20-MF01-30	30W	3/4/5000K	Ra90	48V	2100lm	900x21.6x42.8		Zigbee
R20-MF01-40	40W	3/4/5000K	Ra90	48V	2800lm	1200x21.6x42.8		

Beam angle



R20-MF03-6/12/18

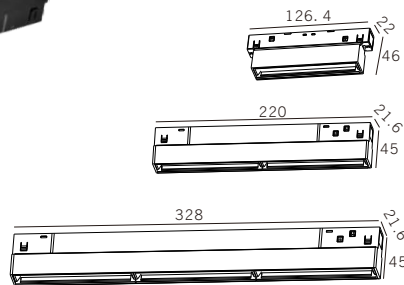

Product Code	Watt	CCT	>CRI	Voltage	LUMEN	Product Size	Finish	System Options
R20-MF03-6	6W	3/4/5000K	Ra90	48V	480lm	126.4x22x46	■ BK	No Dim, Dali,
R20-MF03-12	12W	3/4/5000K	Ra90	48V	960lm	220x21.6x45	□ WH	0-10V, Bluetooth,
R20-MF03-18	18W	3/4/5000K	Ra90	48V	1440lm	328x21.6x45		Zigbee

Beam angle



R20-MFT01-6/12

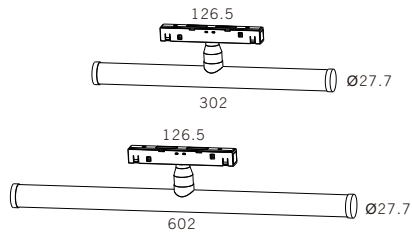

Product Code	Watt	CCT	>CRI	Voltage	LUMEN	Product Size	Finish	System Options
R20-MFT01-6	6W	3/4/5000K	Ra90	48V	600lm	302xØ27.7	■ BK	No Dim, Dali, 0-10V, Bluetooth, Zigbee
R20-MFT01-12	12W	3/4/5000K	Ra90	48V	1200lm	602xØ27.7	□ WH	

Beam angle

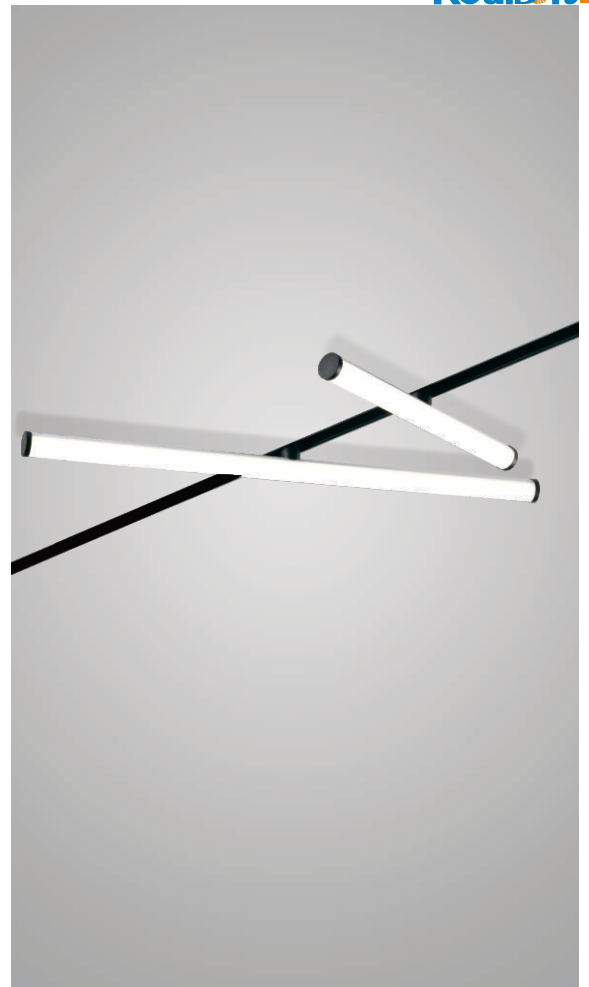

R20-MF02D/IN-20

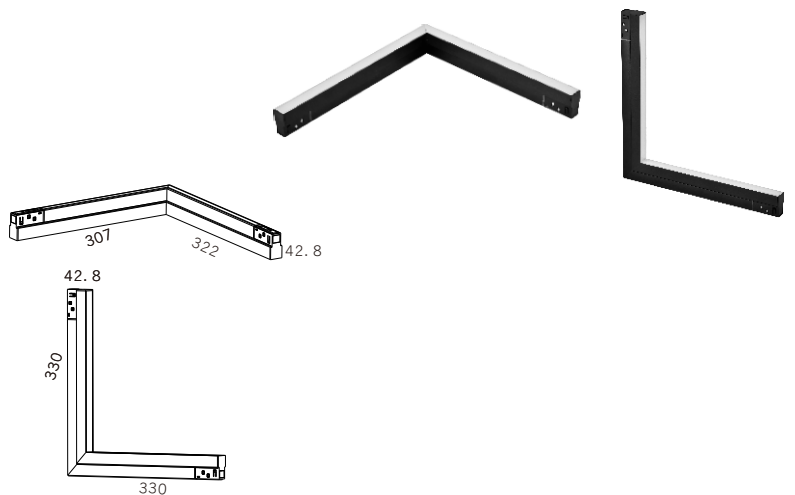

Product Code	Watt	CCT	>CRI	Voltage	LUMEN	Product Size	Finish	System Options
R20-MF02D-20	20W	3/4/5000K	Ra90	48V	1400lm	307x322x42.8	■ BK	No Dim, Dali, 0-10V, Bluetooth, Zigbee
R20-MF02IN-20	20W	3/4/5000K	Ra90	48V	1400lm	330x330x42.8	□ WH	

Beam angle



R20-MS01-3/5

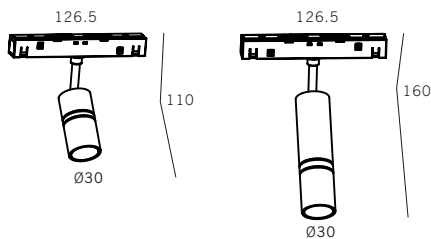

Product Code	Watt	CCT	>CRI	Voltage	LUMEN	Product Size	Finish	System Options
R20-MS01-3	3W	3/4/5000K	Ra90	48V	220lm	Ø30x110x126.5	■ BK	No Dim, Dali, 0-10V, Bluetooth, Zigbee
R20-MS01-5	5W	3/4/5000K	Ra90	48V	280lm	Ø30x160x126.5	□ WH ■ BR	

Beam angle

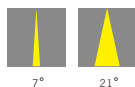

R20-MS01-7/12

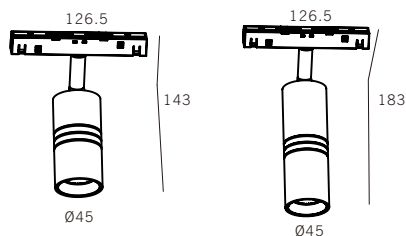
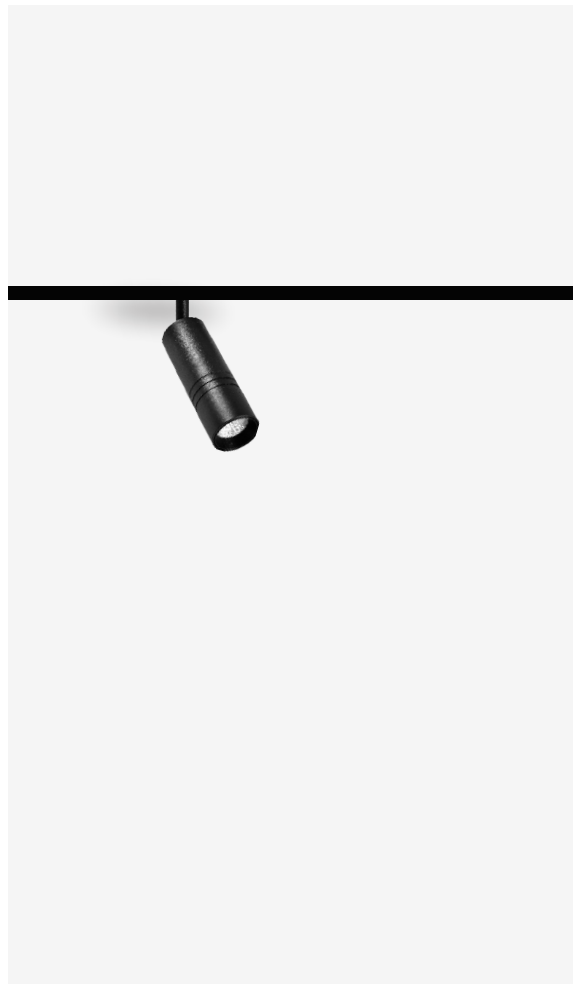

Product Code	Watt	CCT	>CRI	Voltage	LUMEN	Product Size	Finish	System Options
R20-MS01-7	7W	3/4/5000K	Ra90	48V	560lm	Ø45x143x126.5	■ BK	No Dim, Dali, 0-10V, Bluetooth, Zigbee
R20-MS01-12	12W	3/4/5000K	Ra90	48V	960lm	Ø45x183x126.5	□ WH ■ BR	

Beam angle

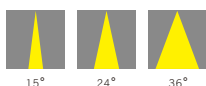

R20-MS01-15/20

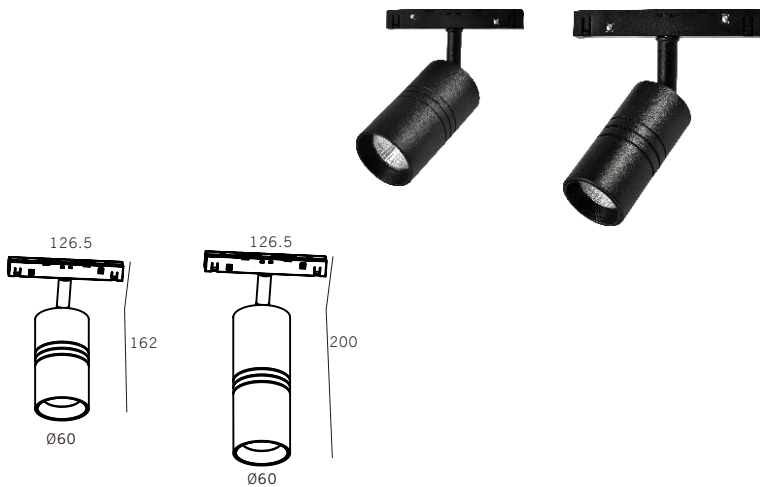

Product Code	Watt	CCT	>CRI	Voltage	LUMEN	Product Size	Finish	System Options
R20-MS01-15	15W	3/4/5000K	Ra90	48V	1200lm	Ø60x162x126.5	■ BK	No Dim, Dali,
R20-MS01-20	20W	3/4/5000K	Ra90	48V	1600lm	Ø60x200x126.5	□ WH ■ BR	0-10V, Bluetooth, Zigbee

Beam angle

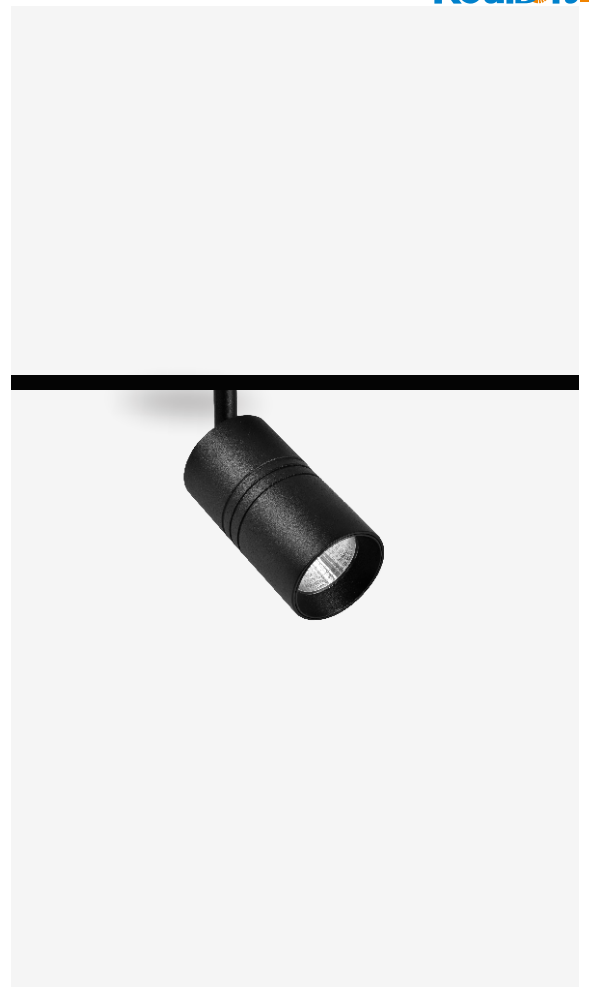
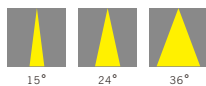

R20-MS04-12/20/30

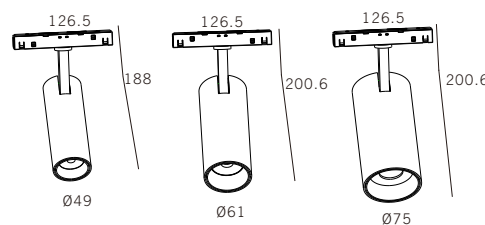

Product Code	Watt	CCT	>CRI	Voltage	LUMEN	Product Size	Finish	System Options
R20-MS04-12	12W	3/4/5000K	Ra90	48V	960lm	Ø49x188x126.5	■ BK	No Dim, Dali,
R20-MS04-20	20W	3/4/5000K	Ra90	48V	1600lm	Ø61x200.6x126.5	□ WH	0-10V, Bluetooth,
R20-MS04-30	30W	3/4/5000K	Ra90	48V	2400lm	Ø75x200.6x126.5	■ BR	Zigbee

Beam angle

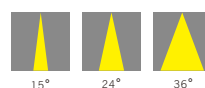

R20-MS02A/B/C-8/16/16

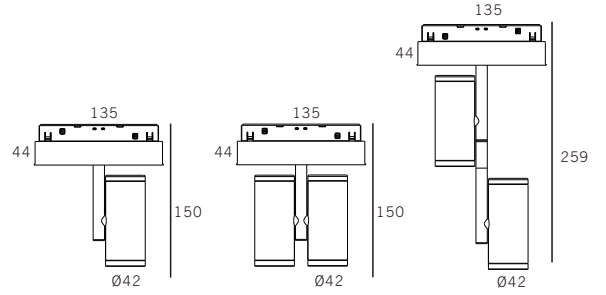
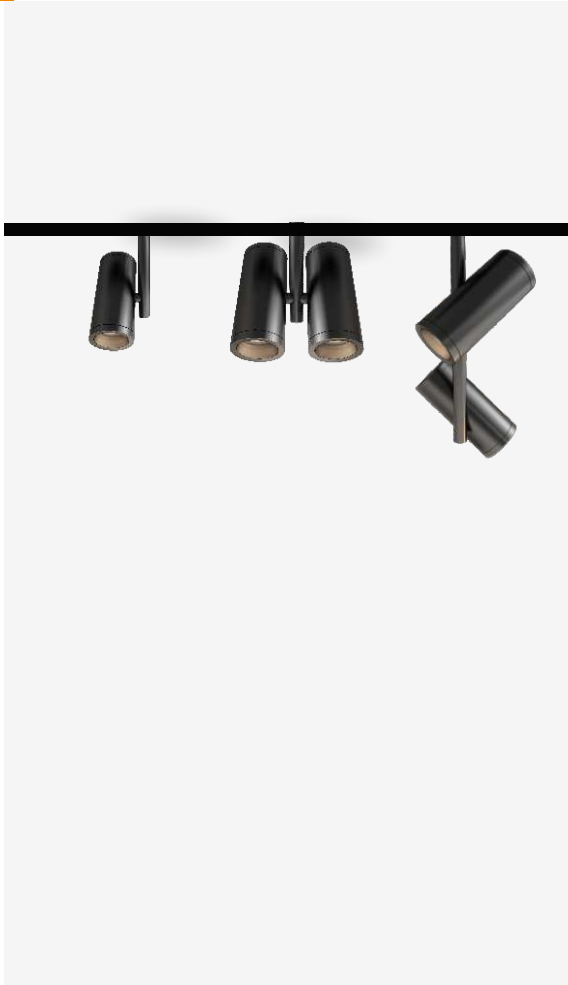

Product Code	Watt	CCT	>CRI	Voltage	LUMEN	Product Size	Finish	System Options
R20-MS02A-8	8W	3/4/5000K	Ra90	48V	540lm	Ø42x150x135	■ BK	No Dim, Dali, 0-10V, Bluetooth, Zigbee
R20-MS02B-16	16W	3/4/5000K	Ra90	48V	1440lm	Ø42x150x135	□ WH	
R20-MS02C-16	16W	3/4/5000K	Ra90	48V	1440lm	Ø42x259x135	■ BR	

Beam angle

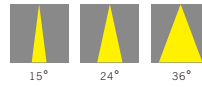

R20-MS03-12

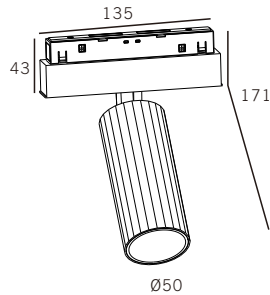

Product Code	Watt	CCT	>CRI	Voltage	LUMEN	Product Size	Finish	System Options
R20-MS03-12	12W	3/4/5000K	Ra90	48V	860lm	Ø50x171x135	■ BK □ WH ■ BR	No Dim, Dali, 0-10V, Bluetooth, Zigbee, Mijia

Beam angle



R20-MG01-6/12/18/24/36

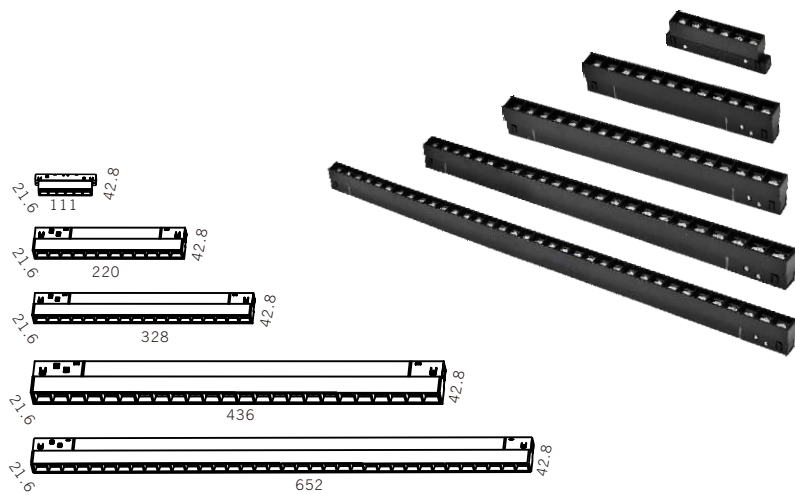

Product Code	Watt	CCT	>CRI	Voltage	LUMEN	Product Size	Finish	System Options
R20-MG01-6	6W	3/4/5000K	Ra90	48V	480lm	111x21.6x42.8	■ BK	No Dim,
R20-MG01-12	12W	3/4/5000K	Ra90	48V	960lm	220x21.6x42.8	□ WH	Dali,
R20-MG01-18	18W	3/4/5000K	Ra90	48V	1440lm	328x21.6x42.8		0-10V,
R20-MG01-24	24W	3/4/5000K	Ra90	48V	1920lm	436x21.6x42.8		Bluetooth,
R20-MG01-36	36W	3/4/5000K	Ra90	48V	2880lm	652x21.6x42.8		Zigbee

Beam angle

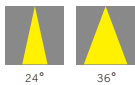

R20-MG02-12

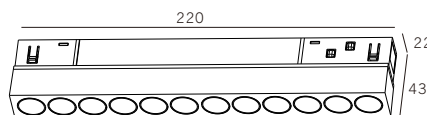
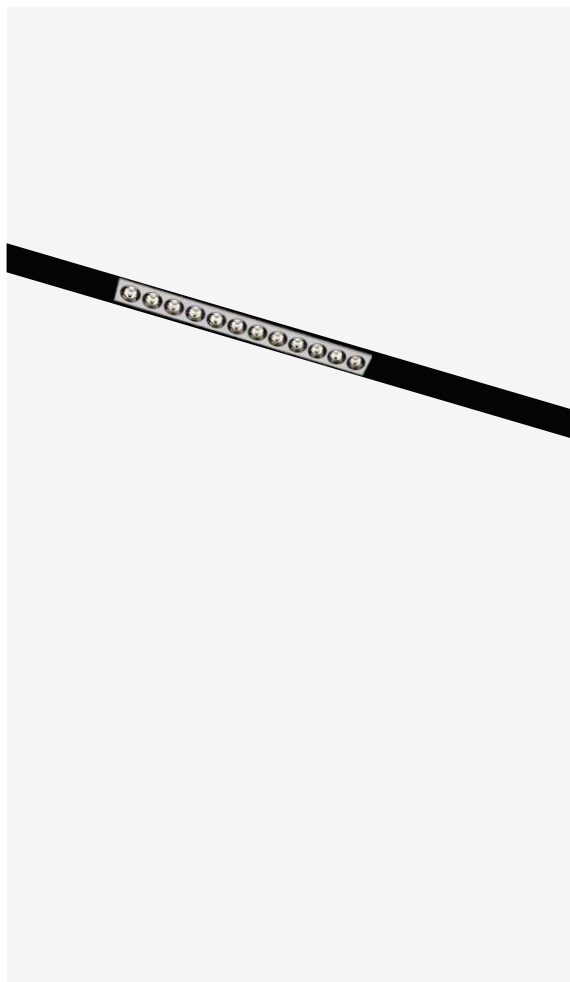

Product Code	Watt	CCT	>CRI	Voltage	LUMEN	Product Size	Finish	System Options
R20-MG02-12	12W	3/4/5000K	Ra90	48V	960lm	220x22x43	■ BK □ WH	No Dim, Dali, 0-10V, Bluetooth, Zigbee

Beam angle



R20-MXG01-6/12

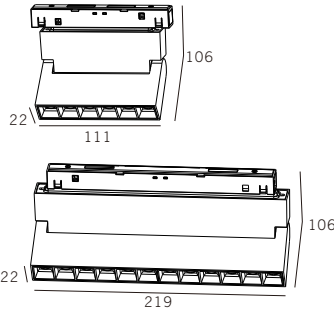

Product Code	Watt	CCT	>CRI	Voltage	LUMEN	Product Size	Finish	System Options
R20-MXG01-6	6W	3/4/5000K	Ra90	48V	480lm	111x22x106	■ BK	No Dim, Dali, 0-10V, Bluetooth, Zigbee
R20-MXG01-12	12W	3/4/5000K	Ra90	48V	960lm	219x22x106	□ WH	

Beam angle

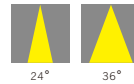

R20-MXF01-6/12

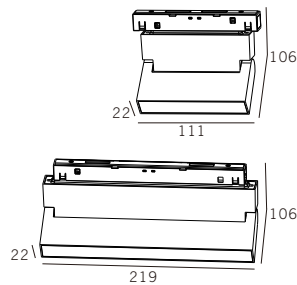

Product Code	Watt	CCT	>CRI	Voltage	LUMEN	Product Size	Finish	System Options
R20-MXF01-6	6W	3/4/5000K	Ra90	48V	420lm	111x22x106	■ BK	No Dim, Dali, 0-10V, Bluetooth, Zigbee
R20-MXF01-12	12W	3/4/5000K	Ra90	48V	840lm	219x22x106	□ WH	

Beam angle



R20-MXG02-12

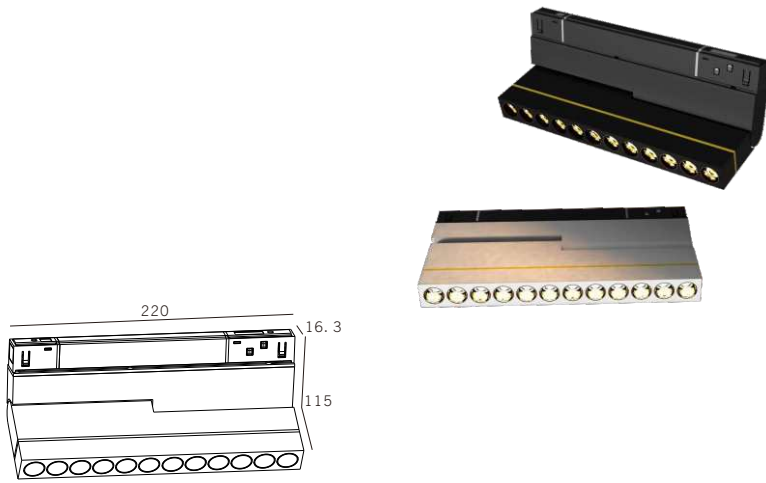

Product Code	Watt	CCT	>CRI	Voltage	LUMEN	Product Size	Finish	System Options
R20-MXG02-12	12W	3/4/5000K	Ra90	48V	960lm	220x16.3x115	<input checked="" type="checkbox"/> BK <input type="checkbox"/> WH	No Dim, Dali, 0-10V, Bluetooth, Zigbee

Beam angle



R20-MDB01/02-12

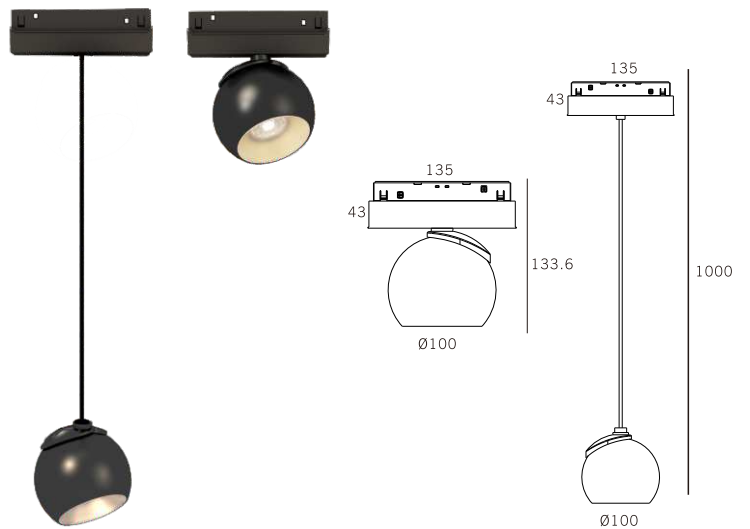

Product Code	Watt	CCT	>CRI	Voltage	LUMEN	Product Size	Finish	System Options
R20-MDB01-12	12W	3/4/5000K	Ra90	48V	960lm	Ø100x133.6x135	<input checked="" type="checkbox"/> BK	No Dim, Dali,
R20-MDB02-12	12W	3/4/5000K	Ra90	48V	960lm	Ø100x1000x135	<input type="checkbox"/> WH <input checked="" type="checkbox"/> GD	0-10V, Bluetooth, Zigbee

Beam angle

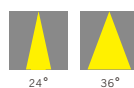

R20-MDR01(02)-10

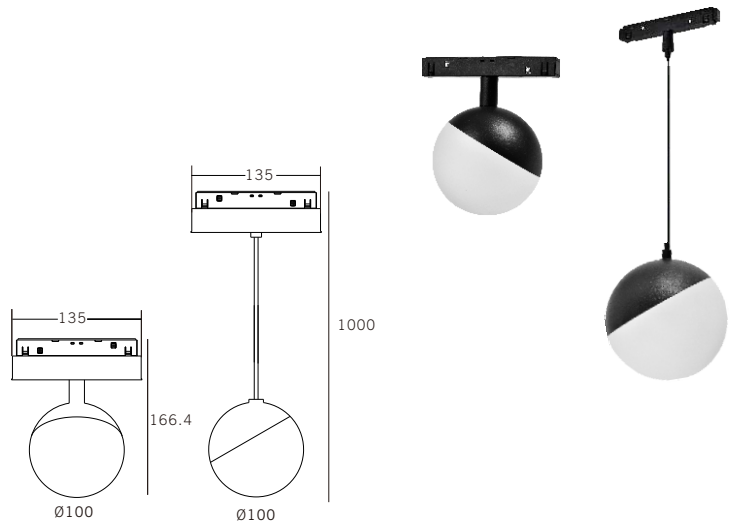
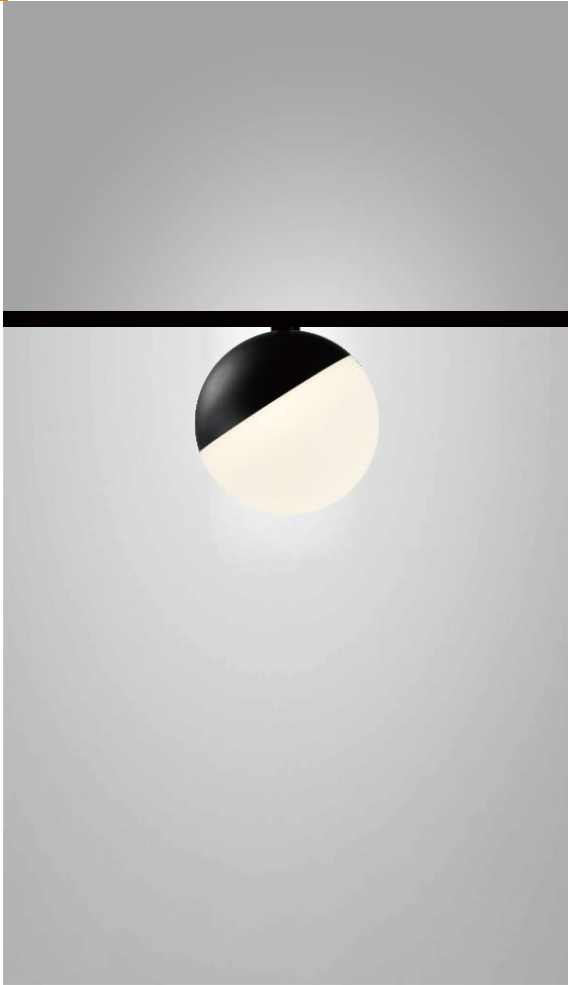

Product Code	Watt	CCT	>CRI	Voltage	LUMEN	Product Size	Finish	System Options
R20-MDR01-10	10W	3/4/5000K	Ra90	48V	800lm	Ø100x166.4x135	■ BK	No Dim, Dali, 0-10V, Bluetooth, Zigbee
R20-MDR02-10	10W	3/4/5000K	Ra90	48V	800lm	Ø100x1000x135	□ WH ■ GD	

Beam angle



R20-MDT01-9

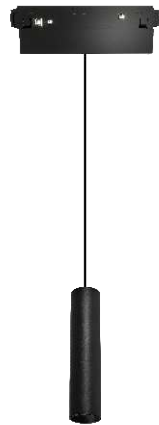
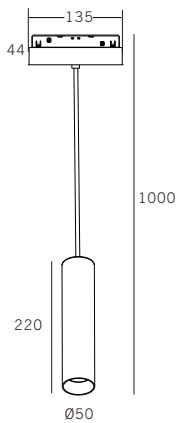

Product Code	Watt	CCT	>CRI	Voltage	LUMEN	Product Size	Finish	System Options
R20-MDT01-9	9W	3/4/5000K	Ra90	48V	720lm	Ø50x1000x135	■ BK □ WH	No Dim, Dali, 0-10V, Bluetooth, Zigbee, Mijia

Beam angle

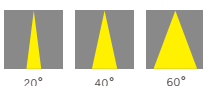

R20-MML-25/30/35 MJL-40/45

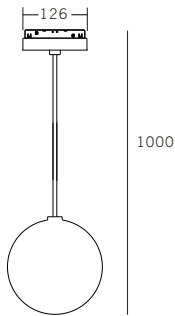

Ø250/300/350/400/450mm

Product Code	Watt	CCT	>CRI	Voltage	LUMEN	Product Size	Material	Finish
R20-MML-25/30/35	24W	3/4000K	Ra80	48V	800lm	Ø250/300mm	PLA	<input type="checkbox"/> WH
R20-MJL-40/45	24W	3/4000K	Ra80	48V	800lm	Ø350/400/450mm	PLA	<input type="checkbox"/> WH

Beam angle



240°

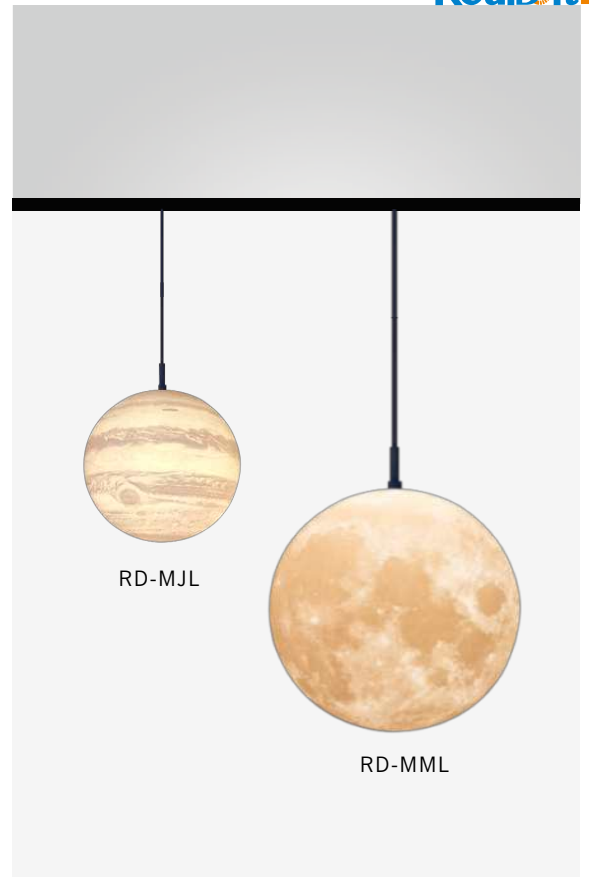

RD-MJL

RD-MML



CONNENTION MODULE



90° connection



Connection



Adaptor



Straight connection



Live end

48V POWER SUPPLY

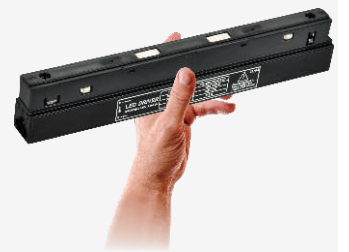

Magnetic support
Easy to position and re-position

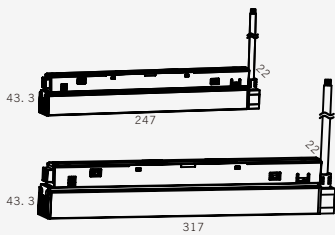

Product Code	Watt	Product Size	Finish	Warranties
R20-P100	100W	247x43.3x22	■ BK	2 years
R20-P200	200W	247x43.3x22	□ WH	2 years

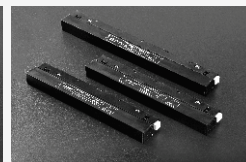
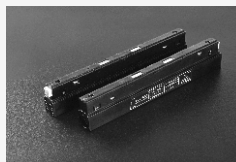



R35

MAGNETIC
TRACK LIGHT

Magnetic35

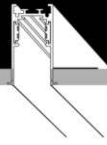

Recessed



Surface

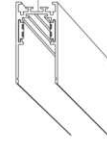

Suspended

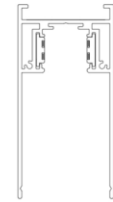
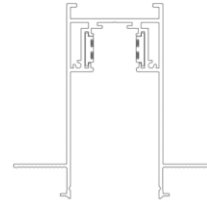

48V Magnetic Track System

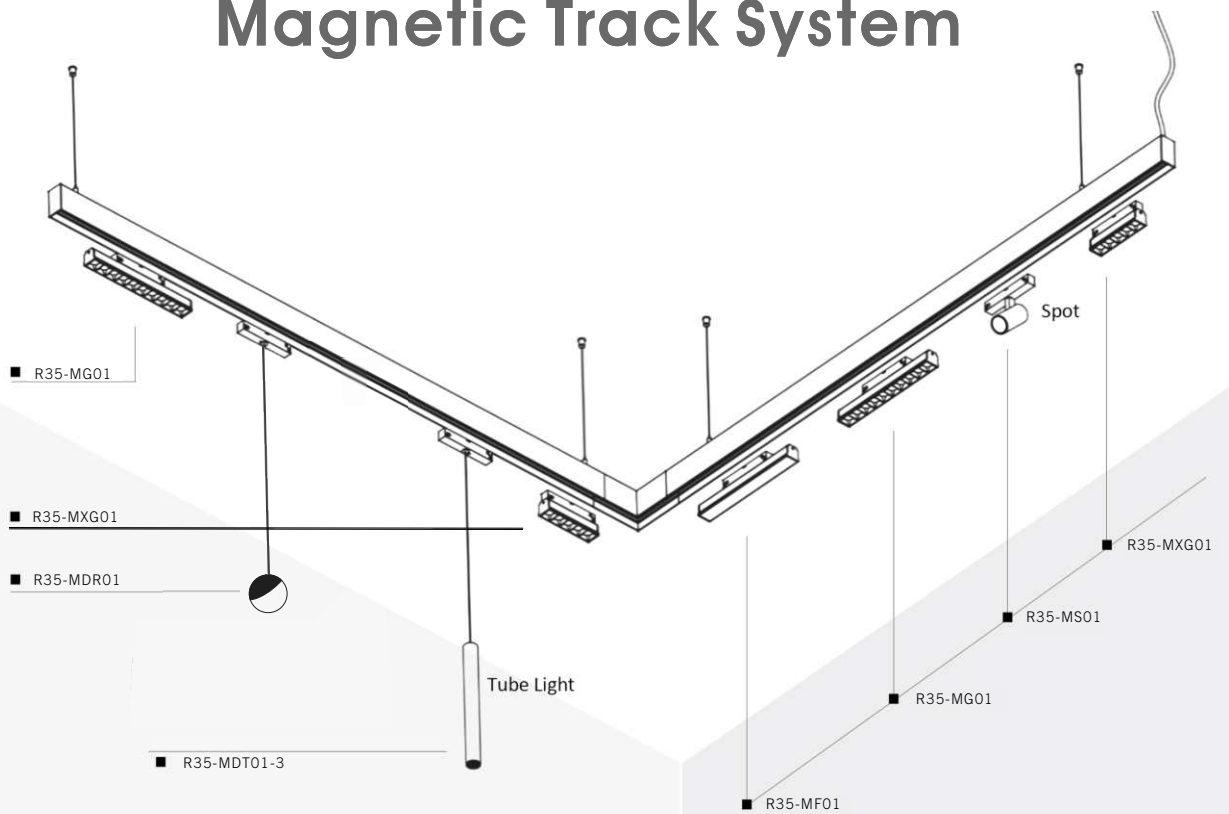

R35-MS01-3/5

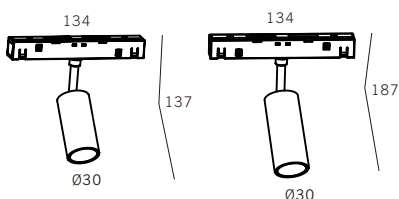

Product Code	Watt	CCT	>CRI	Voltage	LUMEN	Product Size	Finish	System Options
R35-MS01-3	3W	3/4/5000K	Ra90	48V	145lm	Ø30x137x134	■ BK	No Dim, Dali, 0-10V, Bluetooth, Zigbee
R35-MS01-5	5W	3/4/5000K	Ra90	48V	200lm	Ø30x187x134	□ WH	

Beam angle

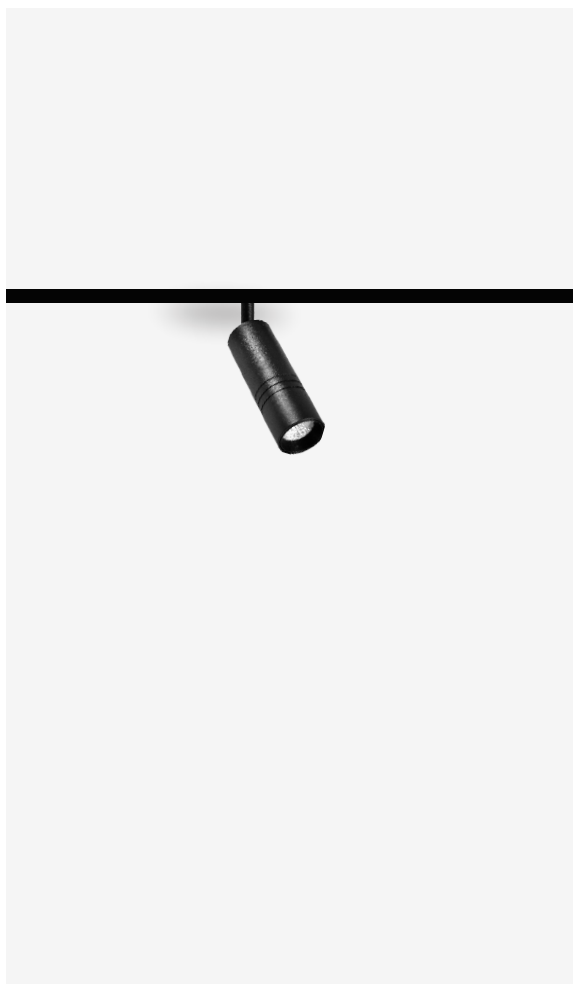
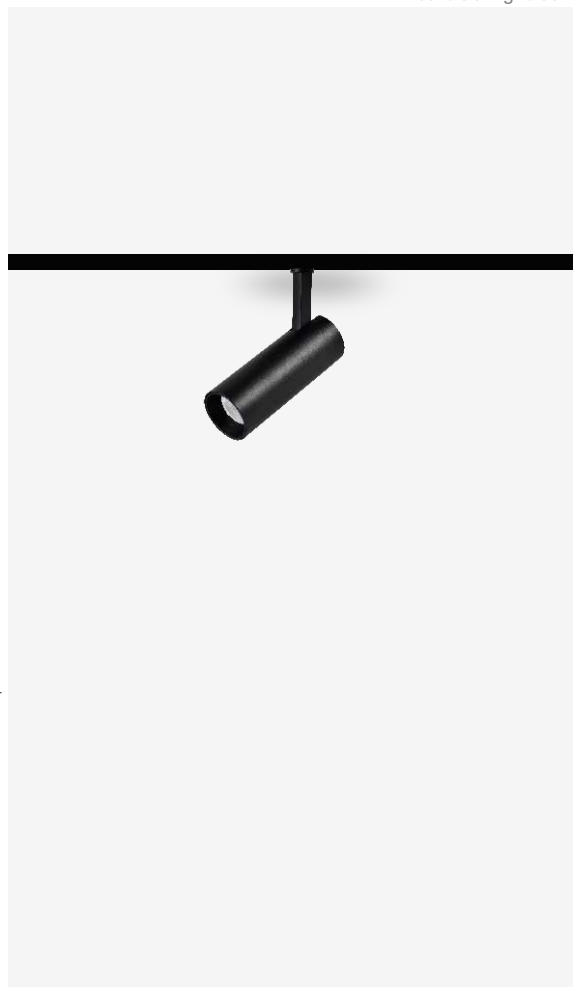

R35-MS02-7/12/16/20

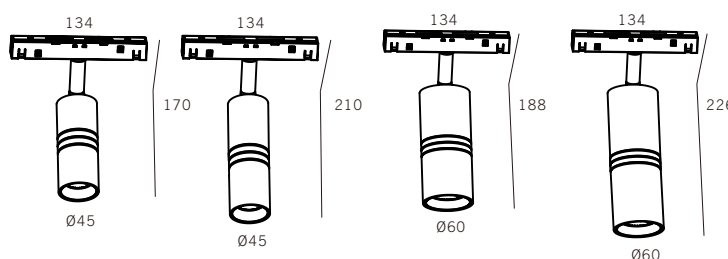

Product Code	Watt	CCT	>CRI	Voltage	LUMEN	Product Size	Finish	System Options
S35-MS02-7	7W	3/4/5000K	Ra90	48V	550lm	Ø45x170x134	■ BK	No Dim, Dali, 0-10V, Bluetooth, Zigbee
S35-MS02-12	12W	3/4/5000K	Ra90	48V	970lm	Ø45x210x134	□ WH	
S35-MS02-16	16W	3/4/5000K	Ra90	48V	1150lm	Ø60x188x134		
S35-MS02-20	20W	3/4/5000K	Ra90	48V	1450lm	Ø60x226x134		

Beam angle

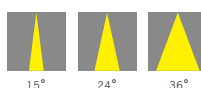

R35-MG01-10/20/30

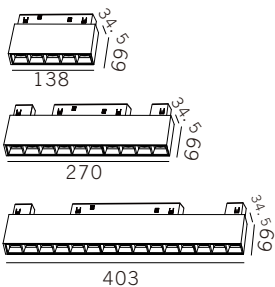

Product Code	Watt	CCT	>CRI	Voltage	LUMEN	Product Size	Finish	System Options
R35-MG01-10	10W	3/4/5000K	Ra90	48V	790lm	138x34.5x69	■ BK	No Dim, Dali, 0-10V, Bluetooth, Zigbee
R35-MG01-20	20W	3/4/5000K	Ra90	48V	1550lm	270x34.5x69	□ WH	
R35-MG01-30	30W	3/4/5000K	Ra90	48V	1950lm	403x34.5x69		

Beam angle

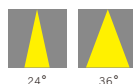

R35-MF01-10/20/30/40

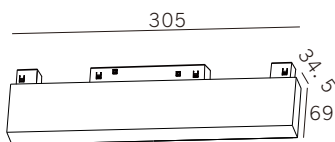

Product Code	Watt	CCT	>CRI	Voltage	LUMEN	Product Size	Finish	System Options
R35-MF01-10	10W	3/4/5000K	Ra90	48V	855lm	305x34.5x69	■ BK	No Dim, Dali, 0-10V, Bluetooth, Zigbee
R35-MF01-20	20W	3/4/5000K	Ra90	48V	1845lm	605x34.5x69	□ WH	
R35-MF01-30	30W	3/4/5000K	Ra90	48V	960lm	905x34.5x69		
R35-MF01-40	40W	3/4/5000K	Ra90	48V	2310lm	1205x34.5x69		

Beam angle



R35-MXG01-10/20

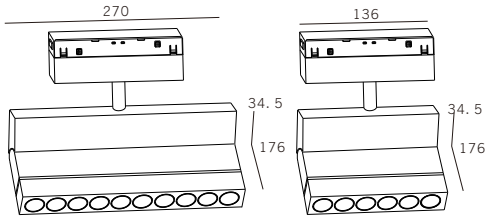

Product Code	Watt	CCT	>CRI	Voltage	LUMEN	Product Size	Finish	System Options
R35-MXG01-10	10W	3/4/5000K	Ra90	48V	690lm	136x34.5x176	■ BK	No Dim, Dali, 0-10V, Bluetooth, Zigbee
R35-MXG01-20	20W	3/4/5000K	Ra90	48V	1350lm	270x34.5x176	□ WH	

Beam angle

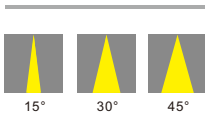

CONNENTION MODULE



Corner Connector



Straight Connector



Straight Connector



Live end

R35-Track Rail

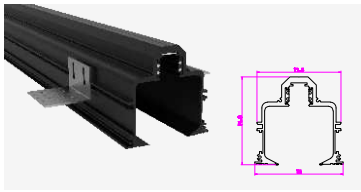

RH35-1

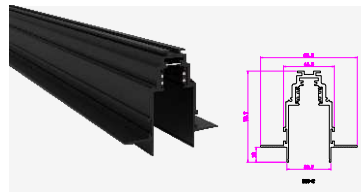

RH35-2

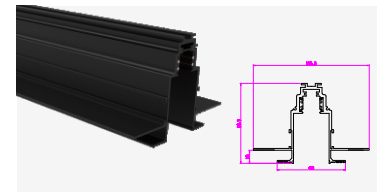

RH35-3

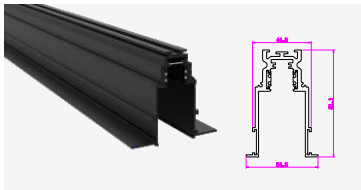

RH35-4

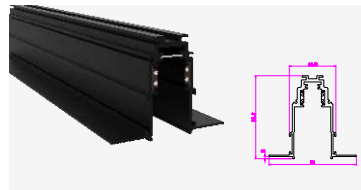

RH35-5

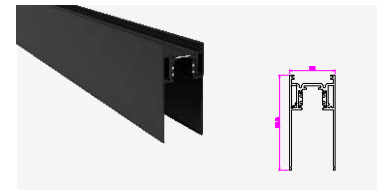

RU35-1

R35-Parts

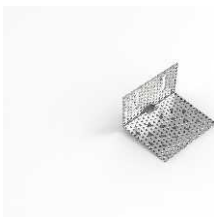

L bracket



Suspension bracket



Bracket with spring

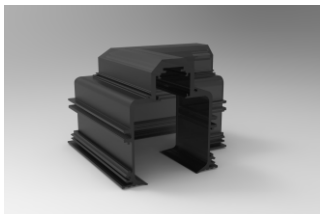

RH35-1
Corner joint

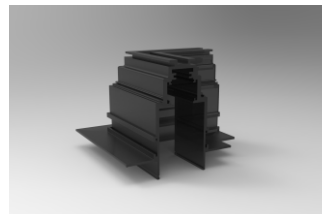

RH35-2
Corner joint

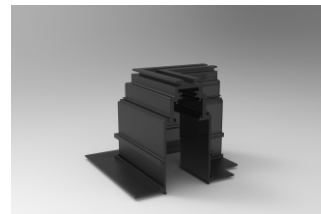

RH35-5
Corner joint

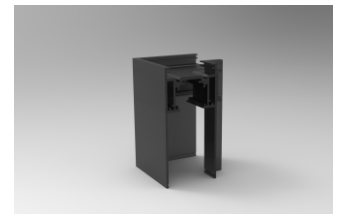

RU35-1
Corner joint

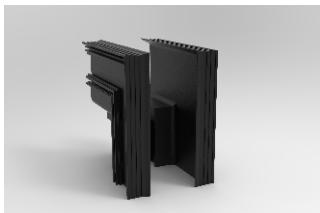

RH35-1
external vertical corner joint

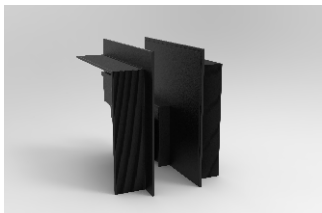

RH35-2
external vertical corner joint

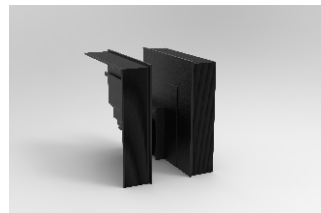

RH35-5
external vertical corner joint

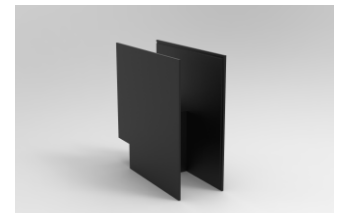

RU35-1
external vertical corner joint

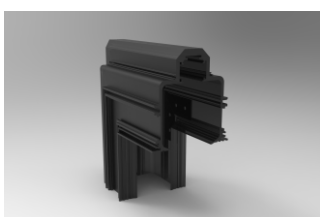

RH35-1
internal vertical corner joint



RH35-2
internal vertical corner joint

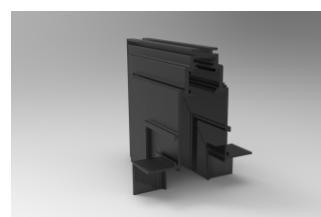

RH35-5
internal vertical corner joint

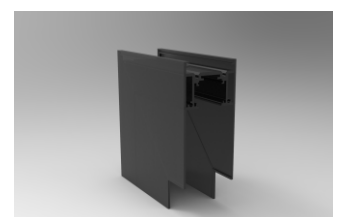

RU35-1
internal vertical corner joint



Realdo

Realdo Electronic Technology Co.,Ltd

Add.: 4th Floor, No. 17 Haizhou Road, Jida Xiangzhou District, Zhuhai City, Guangdong China

Tel : +86-756-3221370 Fax : +86-756-3231831

E-mal : sales@realdoled.com

Website : www.lineartracklight.com

